

**FOR
LIGHT
2023**





ACERCA DE FORLIGHT

Forlight es una marca de iluminación de origen español, creada en Barcelona en 2015, cuyo objetivo es ofrecer soluciones óptimas de iluminación y ventilación al alcance de todos; con diseños que dan carácter a todos los espacios de un entorno residencial, tanto de interior como de exterior.

Avalados por más de 50 años de experiencia de LedsC4, grupo de iluminación al que pertenece, Forlight ofrece una amplia cartera de productos, con el equilibrio óptimo entre coste, tecnología, material, diseño y eficiencia energética.

ABOUT FORLIGHT

Forlight is a Spanish based lighting brand, set up in Barcelona in 2015, whose aim is to offer optimal lighting and fan solutions within everyone's reach; We are putting in faith on designs that give character to all spaces in a residential environment, both indoor and outdoor.

Endorsed by LedsC4's over 50 years' experience, group to which FORLIGHT belongs, we are seeking to provide a wide product portfolio, with the optimal balance between cost, technology, material, design, and energy efficiency.

À PROPOS DE FORLIGHT

Forlight est une marque de luminaires créée en 2015 à Barcelone en Espagne. Offrir des solutions d'éclairage et de ventilation optimales, et à la portée de tous, est son objectif. Forlight présente des designs qui apportent du caractère à tous les espaces résidentiels, tant à l'intérieur qu'à l'extérieur.

Renforcés par plus de 50 ans d'expérience du Groupe LedsC4 auquel Forlight appartient, nous cherchons à offrir un large éventail de produits dont l'équilibre coût, technologie, matériaux, design et efficacité énergétique est optimal.

DISEÑO DE PRODUCTOS

La durabilidad, la facilidad de uso y la eficacia son el ADN de nuestros productos. Las luminarias de Forlight tienen un diseño atemporal, son fáciles de instalar, desarrollan un buen rendimiento y los componentes críticos son fácilmente sustituibles.

PRODUCT DESIGN

Long-lasting, usability, and efficiency are the core of our products. Forlight has designed and engineered each luminaire to have timeless design, to be easily installed, to develop good performance, and for the critical components, to be quickly replaced.

DESIGN DE PRODUIT

La longévité, la facilité d'utilisation et l'efficacité sont au cœur de nos produits. Doté d'un design intemporel, chaque produit de la marque Forlight a été conçu et élaboré pour sa facilité d'installation, ses performances optimales et la possible substitution de ses composants critiques.



FABRICACIÓN DE PRODUCTOS Y CALIDAD

Todas las luminarias Forlight están construidas y fabricadas con materiales robustos y se supervisan minuciosamente durante todas las fases de fabricación, lo que garantiza su buen funcionamiento durante su vida útil.

MANUFACTURING AND QUALITY

All forlight luminaires are constructed and manufactured with robust materials and supervised detailly by 4 quality processes (previous, during and twice verification after manufacturing) which ensures their good performance during its declared lifetime.

FABRICATION ET QUALITÉ

Tous les luminaires Forlight sont élaborés avec des matériaux robustes et leur fabrication est contrôlée dans les moindre détails au cours de quatre processus de suivi qualité (avant, pendant et deux fois après la fabrication) qui garantissent une performance optimale pendant la durée d'utilisation déclarée des produits.

COMPONENTES ELÉCTRICOS Y HOMOLOGACIONES

Las luminarias Forlight se fabrican estrictamente de acuerdo con la normativa europea. El producto integra componentes eléctricos probados EMC y LVD, y LED basados en LM80, para cumplir y garantizar la vida útil declarada de cada luminaria.

ELECTRIC COMPONENTS AND APPROVALS

The forlight luminaires are strictly manufactured in accordance with the European standard. Our product integrates EMC and LVD proved electrical components, and LM80 based LED, to meet and guarantee the declared lifetime of each luminaire.

COMPOSANTS ÉLECTRIQUES ET APPROBATIONS

Les luminaires Forlight sont fabriqués dans le stricte respect du cadre normatif européen. Les luminaires intègrent des composants électriques certifiés conformes EMC et LVD ainsi que des Leds LM80 afin de garantir la durée d'utilisation déclarée de chaque produit.



SERVICIO

Disponer de productos con las especificaciones y la calidad adecuadas en el momento oportuno es la esencia de nuestra marca. Por ello, tenemos stocks permanentes en nuestros almacenes europeos y disponemos de puntos de servicios en más de 140 países, lo que nos permite garantizar una excelente experiencia de compra.

SERVICE

Having products with the right specification and quality at the right time is the essence of our brand. Therefore, we aim to provide excellent experience to customers anywhere in the world, with service points in more than 140 countries, and permanent stocks of all catalogued products, in our European warehouses.

SERVICE

Proposer des produits présentant les meilleures caractéristiques techniques et une qualité optimale à tout moment, c'est l'essence même de notre marque. C'est pourquoi nous offrons à nos clients une excellente expérience partout dans le monde, grâce à nos centres de service répartis dans plus de 140 pays, et grâce à des stocks permanents de tout produit catalogué dans nos entrepôts européens.

MEDIOAMBIENTE

Apostamos por la gestión a largo plazo. Intentamos diseñar productos atemporales, reparables, eficientes y duraderos, y utilizar embalajes con certificación FSC y materiales procedentes de bosques bien gestionados, para generar un impacto social y ambientalmente responsable.

ENVIROMENT

We put in faith on long-term stewardship. We seek to design timeless, repairable, efficient, and long-lasting products, and to use FSC certified packaging, materials come from well managed forest, to be environmentally and socially responsible.

ENVIRONNEMENT

Notre gestion s'inscrit sur le long terme. Nous cherchons à concevoir des produits intemporels, réparables, efficaces et durables, et à utiliser des emballages certifiés FSC, des matériaux provenant de forêts éco responsables afin d'être respectueux sur le plan environnemental et social.



Página web de Forlight Forlight website Site internet de Forlight

www.forlight.com

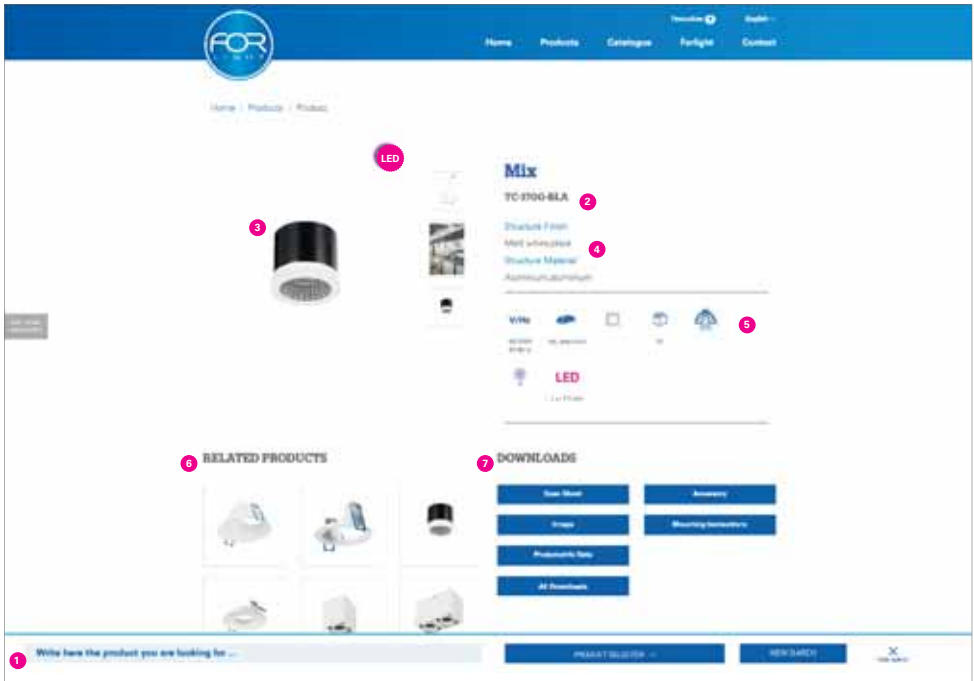

1 Buscador interno.
Site Search.
Outil de recherche interne.

2 Modelo y referencia del
producto según su acabado.
Product model and
reference number based on
characteristics.
Modèle y référence del
produit selon son fini.

3 Imagen de producto aislado,
en ambiente y dimensiones.
Product only image, product in
use image and dimensions.
Image du produit isolé, sur site
et dimensions.

4 Información de materiales
y acabados.
Information about Materials
and Finishes.
Informations matériaux
et finitions.

5 Simbología.
Symbols.
Symboles.

6 Productos y accesorios
relacionados.
Related products and
accessories.
Produits et accessoires
connexes.

7 Descarga de todos los datos.
Download all the information.
Téléchargement de toutes les
données.



¿Cómo utilizar este catálogo? How to use the catalogue? Comment s'utilise ce catalogue?

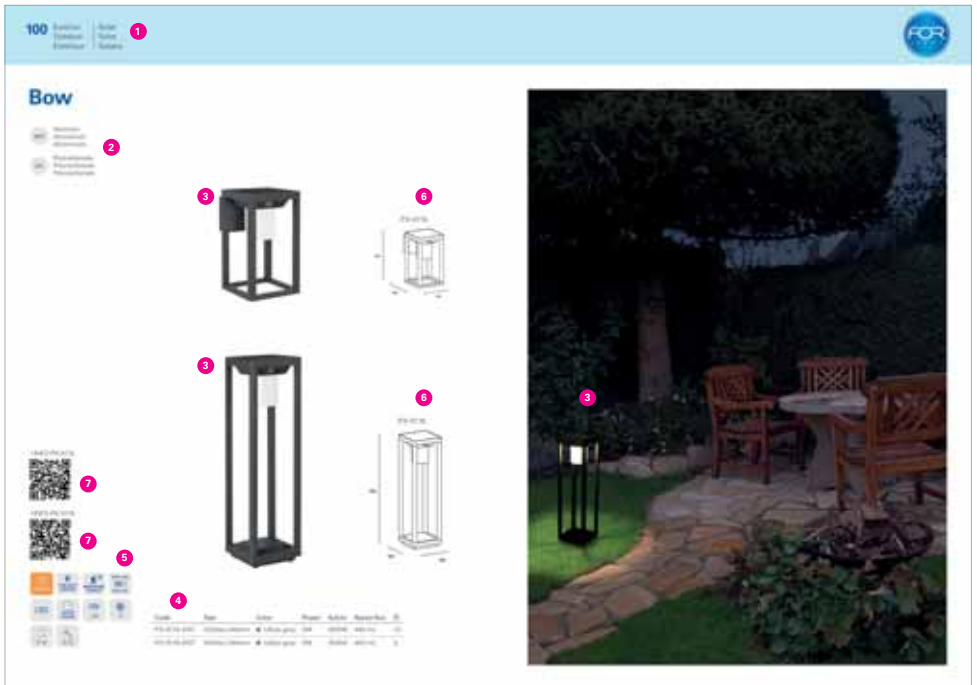

1 Sección de producto dentro del catálogo.
Product Section in the Catalogue.
Type de produits du catalogue.

2 Información de materiales.
Materials information.
Informations sur les matériaux.



















3 Imagen de producto aislado y en ambiente.
Isolated Product and Assembled Product Images.
Image du produit seul et ambiances.



















4 Referencia de producto según información específica de cada uno.
Product reference according to specific information of each product.
Référence du produit selon les informations spécifiques au produit.

















5 Características técnicas y de utilidad del producto.
Technical Characteristics and Product Use.
Caractéristiques techniques et utilisation du produit.

6 Dimensiones y montaje del producto.
Measures and Product Assembly.
Dimensions et montage du produit.

7 QR para escanear y obtener información adicional del producto.
QR to scan and get additional product information.
QR à scanner pour obtenir des informations supplémentaires sur le produit.

	Uso apto para 3000h/año.	Suitable for 3000h/year.	Utilisation adaptée à 3000h/an.
	Adecuada para instalar en ambientes con atmósfera marina.	Suitable for installation in environments with marine atmosphere.	Adapté pour une installation en milieu marin.
	Luminaria alimentada con energía solar.	Solar-powered luminaire.	Luminaire alimenté par énergie solaire.
	Sensor crepuscular.	Twilight sensor.	Capteur crépusculaire.
	Confort visual.	Visual comfort.	Confort visuel.
	Sensor de movimiento por infrarrojo.	PIR sensor.	Capteur de mouvement infrarouge.
	Sensor de movimiento por microwave.	Microwave motion sensor.	Capteur de mouvement à micro-ondes.
	Regulador de intensidad.	Dimmer.	Régulateur d'intensité.
	Regulación por corte de fase.	Phase cut.	Coupe de phase.
	Selección de temperatura de color.	Selection of color temperature.	Choix de la température de la couleur.
	Encendido táctil.	Touch.	Allumage tactique.
	Luminarias conectables.	Smart light fittings.	Luminaire connectables.
	Luminarias conectables con Bluetooth.	Bluetooth smart light fittings.	Luminaire connectables via Bluetooth.
	Luminarias conectables con WiFi.	Wi-Fi smart light fittings.	Luminaire connectables via WiFi.
	Regulación progresiva de temperatura de color.	Stepless color temperature control.	Contrôle progressif de la température de la couleur.
	Regulación de colores RGB.	RGB color regulation.	Régulation des couleurs RGB.
	Luminaria con batería.	Battery operated luminaire.	Lampe avec batterie.
	Puerto USB.	USB port.	Le port USB.
	Fuente de luz LED.	LED light source.	Source de lumière LED.

	Portalampara QR-111.	QR-111 lamp socket.	Porte-lampe QR-111.
	Portalampara GU10.	GU10 lamp socket.	Porte-lampe GU10.
	Portalampara E27.	E27 lamp socket.	Porte-lampe E27.
	Portalampara E14.	E14 lamp socket.	Porte-lampe E14.
	Portalampara R7s.	R7s lamp socket.	Porte-lampe R7s.
	Horas de vida útil.	Lifetime in hours.	Durée de vie utile.
	Voltaje / Frecuencia.	Voltage / Frequency.	Voltage / Fréquence.
	Alimentación por USB.	Powered by USB.	Alimenté par USB.
	Alimentación a 12V.	12V power supply.	Alimentation électrique de 12V.
	Led reemplazable por un profesional.	Professional replaceable LED.	Led remplaçables par un professionnel.
	Driver reemplazable por un profesional.	Driver replaceable by a professional.	Pilote remplaçable par un professionnel.
	Equipo electrónico incluido.	Electronic gear included.	Équipement électronique inclus.
	Equipo necesario (no incluido).	Gear needed (not included).	Équipement nécessaire (non inclus).
	Permite instalación en serie,	Allows serial installation.	Permet un montage en série.
	Class I.	Class I.	Class I.
	Class II.	Class II.	Class II.
	Class III.	Class III.	Class III.
	Índice de Reproducción Cromática.	Color Rendering Index.	Indice de rendu des couleurs.
	Índice de Deslumbramiento Unificado.	Unified Glare Rating.	Taux d'éblouissement unifié.

	Ángulo de las ópticas.	Lents angle.	Angle des lentilles.
	Fotometría disponible.	Photometric data available.	Données photométriques disponible.
	Orientable en eje horizontal.	Orientable on the horizontal axis.	Orientable sur axe horizontal.
	Basculante en dos sentido.	Two-way tilting.	Inclinaison bidirectionnelle.
	Orientable en eje vertical.	Orientable on the vertical axis.	Orientable sur axe vertical.
	Basculante en un sentido.	One way tilting.	Basculement dans une direction.
	Grado de protección proporcionado por un envoltorio contra la entrada de elementos sólidos y líquidos.	Degree of protection that a casing provides against the penetration of solid objects or dust and liquids.	Degré de protection contre la pénétration de corps solides, poussières et liquides.
	Grado de protección proporcionado por un envoltorio contra los impactos mecánicos nocivos.	Level of protection that a casing provides against damaging mechanical impacts.	Degré de protection procuré par une enveloppe contre les impacts mécaniques nuisibles.
	Luminarias no adecuadas para cubrirse con material aislante térmico.	Luminaires should never be covered with any heat insulating material.	Ces luminaires ne doivent pas être recouverts de matériau thermo-isolant.
	Metros de cable incluido.	Meters of cable included.	Mètres de câbles inclus.
	Estaca incluida.	Spike included.	Piquet inclus.
	Caja para empotrar incluida.	Recessed box included.	Boîte à encastrer incluse.
	Unidades por caja master.	Units per master box.	Unités par carton master.
	Consultar disponibilidad.	Check availability.	Vérifiez la disponibilité.
	Producto nuevo.	New product.	Nouveau produit.
Rated flux	Lúmenes nominales.	Nominal lumens.	Lumens nominaux.
Ventiladores Ceiling fans Ventilateurs de plafond			
	Con iluminación.	With lighting.	Avec éclairage.
	Sin iluminación.	No lighting	Pas d'éclairage.

	Flujo de aire.	Air flow.	Flux d'air.
	Motor DC.	DC motor.	Moteur DC.
	Velocidades.	Speeds.	Vitesses.
	Mando a distancia.	Remote control.	Télécommande.
	Palas reversibles.	Reversible blades.	Lames Réversibles.
	Función inversa invierno - verano.	Inverse function winter - summer.	Fonction inverse hiver - été.
	Ultra silencioso.	Ultra-quiet.	Ultra-silencieux.

Novedades New Nouveautés



Downlights empotrados
Recessed downlights
Downlight encastrés

Jim
56



Downlights empotrados
Recessed downlights
Downlight encastrés

Sicro
60



Iluminación modular para techo
Modular downlight
Plafond d'éclairage modulaire

Mix
76, 77



Luminaria de superficie
Surface mounted
Luminaire de surface

Stac
78, 332



Proyector
Spotlight
Projecteur

Lis
96, 128



Empotrable de suelo
Uplight recessed
encastré sol

Up
106



Empotrable de suelo
Uplight recessed
encastré sol

Incasso
108



Señalización
Signaling
Signalisation

Way
132

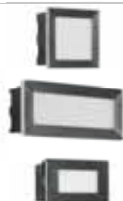

Empotrable de pared
Recessed wall fixture
Aplicue encastré

Rect
140, 141



Aplicues de pared
Wall fixtures
Aplicues

Moo
158



Aplicues de pared
Wall fixtures
Aplicues

Block
166



Apliques de pared
Wall fixtures
Apliques

Tilt
186



Apliques de pared
Wall fixtures
Apliques

Prisma
194



Apliques de pared
Wall fixtures
Apliques

Foix
196



Apliques de pared
Wall fixtures
Apliques

Slim
208



Luminaria de superficie
Surface mounted
Luminaire de surface

Scal
262



Colección
Family
Familie

Pixa
278, 279



Colección
Family
Familie

Hida
276, 277



Colección
Family
Familie

Cone
282



Colección
Family
Familie

Brit
274



Colección
Family
Familie

Elaine
280



Colección
Family
Familie

Lamtam
284



Chill out
Chill out
Chill out

Sirina
300



Chill out
Chill out
Chill out

Treta
302



Luz de lectura
Reading light
Lampe de lecture

Colo
350



Luz de lectura
Reading light
Lampe de lecture

Mine
354



Luz de lectura
Reading light
Lampe de lecture

Aura
360



Luz de lectura
Reading light
Lampe de lecture

Janet
364



Aplique de pared
Wall fixture
Aplique

Ander
366



Aplique de pared
Wall fixture
Aplique

Roc
368



Colección
Family
Familie

Meds
400, 401



Baños
Bath
Salle de bains

Feu
65, 408



Baños
Bath
Salle de bains

Ter
66, 410



Baños
Bath
Salle de bains

Rame
67, 412



Baños
Bath
Salle de bains

Lab
67, 412



Baños
Bath
Salle de bains

Fab
74, 414



Baños
Bath
Salle de bains

Giro
416



Baños
Bath
Salle de bains

Nora
420



Baños
Bath
Salle de bains

Metà
424

Ventiladores Ceiling fan Ventilateurs de plafond



Ventiladores
Ceiling fan
Ventilateurs de plafond

Mim
432



Ventiladores
Ceiling fan
Ventilateurs de plafond

Bambu
434



Ventiladores
Ceiling fan
Ventilateurs de plafond

Cil
436



Ventiladores
Ceiling fan
Ventilateurs de plafond

Merak
438



Ventiladores
Ceiling fan
Ventilateurs de plafond

Zonda
440



Mix
34



Easy
35



Oira
35



Zip
36



Neo
37



Dual
37

SMART

Técnico Technical Technique



Element
40



Easy
42, 43



Jet
44



Hide
46

Downlights empotrados Recessed downlights Downlight encastrés



Wide
47



Bala
48



Base
50



Dorit
52



Mode
54



N Jim
56



Cardan
58



Cardan
59



N Sicro
60



Sound Plus
62



Minor
64



N Feu
65



N Ter
66



N Rame
67



N Lab
67

Downlights de superficie Surface downlights Downlight de surface



Easy Surface
69, 70



Fox
72



N Fab
74

Iluminación modular para techo
Modular downlight
Plafond d'éclairage modulaire



N Mix
76, 77

N FIXED

N ADJUSTABLE

N SQUARE FIXED

76, 77



DEEP

VISUAL COMFORT

VISUAL COMFORT ADJUSTABLE

N IP65

SURFACE

76, 77

Luminaria de superficie
Surface mounted
Luminaire de surface



N Stac
78

Ilo
80

Pop
82

Proyector de carril
Track spotlight
Projecteur et rail



Tent
84

Arch
86

Key
86

Cone
88

Panel led
Led panel
Pavé led



Square eco
90

Square
90



N Lis
96



Top
98



Bow
100



Deco
102

SOLAR

Exterior Outdoor Extérieur



N Up
106



N Incasso
108



Ringo
110, 111



Tidian
112

Empotrable de suelo
Uplight recessed
Encastré sol



N Pixa
114



Hit
116



Icaro
118



Jumbo
120



Post
122



Neo
124



Tidian
124

Proyectores
Spotlights
Projecteurs



Minimal Green
126



Minimal
126



N Lis
128



Pro
130

Señalización
Signaling
Signalisation



N Way
132



Senya
134



Sort
136

Empotrable de pared
Recessed wall fixture
Aplique encastré



Icon
138



N Rect
140, 141



Stair
142



Face
142



Tamesis
144

**Apliques de pared
Wall fixtures
Apliques**



N Hide
146, 147



Nod
148



Grove
150, 152, 154



Mocca
156



N Moo
158



New flash
160



Vit
162



Area
164



N Block
166



Thomas
168



Opalo
170



Monaco
172



Bow
174



Nika
176



kala
178



Serenate
180



Samper
180



Mayor
182



Top
184



N Tilt
186



Pixa
188



Eleve
190



N Cone
192



N Prisma
194



N Foix
196



Kubo
198



Cube
200



Ara
202



Loyd
204



Orion
206



N Slim
208



Willow
210



Courbe
212



Kapa
214



Shape
216



Rex
218



N Brit
220



Yika
222



Indoo 222 **Corande** 223 **N Elaine** 224 **N Lamtam** 226 **Avenue** 228 **Osaka** 229 **Adur** 230 **Elix** 232 **Siluet** 232



Alfil 233 **Koral** 233 **Grow** 234 **Box** 236 **Balizas Bollards Balises** **N Brit** 238 **N Hide** 240 **N Cone** 242



N Pixa 244 **N Lamtam** 246 **N Elaine** 248 **Kala** 250 **Yika** 251 **Bow** 252 **Top** 253 **Koral** 254



Arrow 255 **Indoo** 255 **Mandela** 256 **Siljan** 257 **Siros** 257 **Box** 258 **Alfil** 259 **Farolas Street lights Lampadaires** **N Pixa** 260 **Siros** 261



Luminaria de superficie
Surface mounted
Luminaire de surface

N Scal 262 **Ford** 264 **Orion** 264 **Rhino** 266 **Selene** 268 **Port** 270 **Pop** 272

**Colección
Family
Famille**



N Brit
274

N Hide
276, 277

N Pixa
278, 279

N Elaine
280



N Cone
282

N Lamtam
284

Kala
286

Yika
288

Koral
290, 291

Indoo
292



Siros
294, 295

Alfil
296

Box
298

**Chillout
Chillout
Chillout**

N Sirina
300

N Treta
302

Deco
304



Night
306

Mush
308

Moon
310

Sphere
310

Decorativo Decorative Décoratif

Colgantes Pendants Suspensions



Riba
314

Meg
316

Lampa
318

Maya
320

Bowl
322



Nube
324

Kea
326

Vira
328

Era
328

Thin
330



Luminaria de superfície Surface mounted Luminaire de surface

Stac
332

Tempo wood
334

Tempo
336

Olra
338

Farrow
340



Serie de focos Spot series Séries de spots

Era
342

Keeper
344



Safran
346



Logos
348

Luz de lectura
Reading light
Lampe de lecture



N Colo
350

Era
352

N Mine
354

Crobat
356

Bas
358

Llit
358



N Aura
360

Lyon
362

N Janet
364

Aplique de pared
Wall fixture
Aplique

N Ander
366

N Roc
368



Keep
370

Toppi
372

Thin
374

N Meds
376

Glass
378

Niza
378

Sobremesas
Table Lamps
Lampes de table

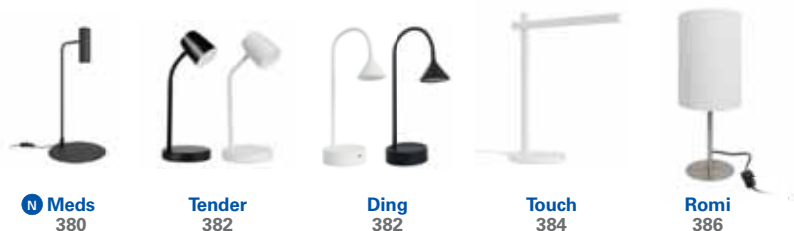

N Meds
380

Tender
382

Ding
382

Touch
384

Romi
386



Nuts
386

Night
388

Mush
390

Magnet
392

Pie de salón
Floor lamps
Lampadaires



N Meds
394

Ding
396

Lampa
398

Colección
Family
Familie

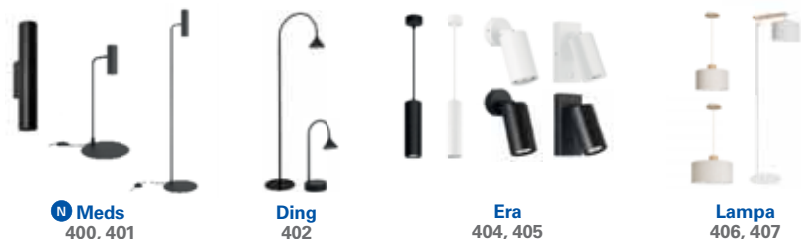

N Meds
400, 401

Ding
402

Era
404, 405

Lampa
406, 407

Baños
Bath
Salle de bains



N Feu
408

N Ter
410

N Rame
412

N Lab
412

N Fab
414

N Giro
416



Petit
418



Vapor
418



N Nora
420



Lungo
422



N Metà
424

Ventiladores Ceiling fan Ventilateurs de plafond



N Mim
432



N Bambu
434



N Cil
436



N Merak
438



N Zonda
440



Bosc
442



Shadow
444



Stem
446



Stem
448



Klar
450



Windy
452



Phuket
454



Xaloc
456



Xaloc
457



Embat
458



Mariner
460



Formentera
462



Pam
464



Buran
466



Inca
468



Kai
470



Bora
472



Tupai
474



Nepal
476



Helix
478



Lodos
480



Tramuntana
482



Garbí
484



Tiga
486



Gregal
488



Sirocco
490



Mogan
492



Lace
494



Handia
495



Calima
496



Borneo
498



Kudari
500

Rodas
502

Hawai
504

Samal
506



Bars
507



Wall control (3 speeds)
507



Wall control
(3 speeds and light on/off)
507



Remote control
507



SMART

Forlight Smart



Bienestar, confort y seguridad de las personas

La nueva gama de producto **Forlight Smart** está pensada para poner el foco en el bienestar de las personas, adaptando la luz a las necesidades de la estancia y del momento, y crear y transformar diferentes ambientes.

Wellness, comfort and safety of people

The new **Forlight Smart** product range is designed to focus on people's well-being, by adapting the lighting to the room's needs and the moment, while creating and transforming different settings.

Bien-être, confort et sécurité des personnes

La nouvelle gamme de produits **Forlight Smart** est conçue pour mettre l'accent sur le bien-être des personnes, en adaptant la lumière aux besoins de la pièce et du moment, de manière à créer et transformer différentes ambiances.



LightForLife APP

Descarga la APP **LightForLife**, **conecta tus luminarias forlight smart**, y crea el ambiente que necesitas para cada momento.

Download the **LightForLife** APP, connect your forlight smart luminaires, and create the atmosphere you need for every moment.

Téléchargez l'APP **LightForLife**, connectez vos luminaires intelligents forlight et créez l'ambiance dont vous avez besoin à chaque instant.



SIRI



ALEXA



GOOGLE ASSISTANT

Beneficios



Luz confortable y adaptable.

Permite adaptar la luz a cada momento: una iluminación cálida por la noche para ayudar a la relajación y una atmósfera neutra o fría a mediodía que nos estimula para estar más activos.



Ahorro energético. Con la ayuda de la tecnología podemos optimizar el uso de la energía para reducir su consumo: crea escenas, horarios, modo "vacaciones," etc.



Experiencia óptima. De fácil instalación y uso, cualquier miembro de la familia puede controlar la iluminación desde cualquier punto de la casa o del exterior.



Integración con otros sistemas.

Posibilidad de control por voz con Siri, Amazon Alexa y Google Assistant.

Advantages

Comfortable, adaptable lighting.

The light can be adapted to suit each moment: warm lighting at night to help you relax and a neutral or cool atmosphere at midday that stimulates the body to be more active.

Energy savings. With the help of technology, you can optimise energy usage to reduce power consumption: create scenes, timetables, "holiday" mode, etc.

Optimal experience. Easy to install and use, any family member can control the lighting from anywhere in the house or outside.

Integration with other systems.

Voice control option with Siri, Amazon Alexa and Google Assistant.

Bienfaits

Lumière confortable et adaptable.

Permet d'adapter la lumière à chaque moment : un éclairage chaud la nuit pour contribuer à la relaxation et une atmosphère neutre ou froide le midi pour nous stimuler afin d'être plus actifs.

Économies d'énergie. Avec l'aide de la technologie, on peut optimiser l'utilisation de l'énergie pour en réduire la consommation : création de scènes, horaires, mode « vacances », etc.

Expérience optimale. Grâce à sa facilité d'installation et d'utilisation, n'importe quel membre de la famille peut contrôler l'éclairage de n'importe quel endroit de la maison ou de l'extérieur.

Intégration avec d'autres systèmes.

Possibilité de contrôle par la voix avec Siri, Amazon Alexa et Google Assistant.





¿CÓMO FUNCIONA?

1. Descarga la app a través del **código QR**.
2. Instala la luminaria según las instrucciones.
3. Abre la **APP LightForLife**. ¡Asegúrate que estás conectado al Wi-Fi!
4. Busca la luminaria en la **APP** y sincronízala siguiendo las instrucciones.
5. ¡Empieza a experimentar!

HOW DOES IT WORK?

1. Download app through **QR code**.
2. Install the luminaire according to the instructions.
3. Open the **LightForLife APP**. Make sure you're connected to Wi-Fi!
4. Find the luminaire in the **APP** and synchronize it following the instructions.
5. **Start experimenting!**

COMMENT ÇA FONCTIONNE?

1. Téléchargez l'application via le **code QR**.
2. Installez le luminaire selon les instructions.
3. Ouvrez l'application **LightForLife**. Assurez-vous d'être connecté au Wi-Fi!
4. Trouvez le luminaire dans l'**APP** et synchronisez-le en suivant les instructions.
5. **Commencez à expérimenter!**



SMART

DE-0513-BLA



HABITACIÓN Suave despertar

Despiértate con una iluminación progresiva que haga tu despertar más cómodo y tranquilo.

BEDROOM Gentle awakening

Wake up with a progressive lighting that makes your awakening comfortable and peaceful.

CHAMBRE Réveil en douceur

Réveillez-vous avec un éclairage progressif qui rend votre réveil plus confortable et plus calme.

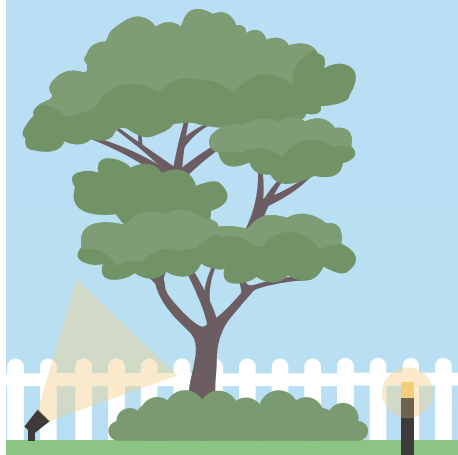
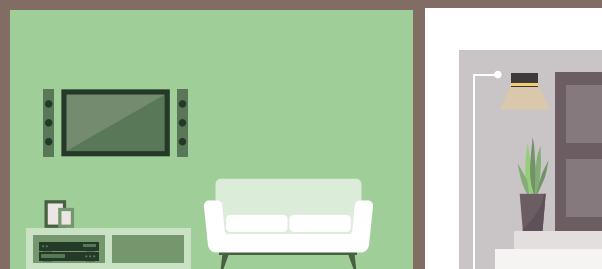

PX-0514-ANT

PX-0516-NEG

PX-0515-ANT



JARDÍN Programaciones horarias

Haz que tus luminarias de exterior se enciendan a una determinada hora para acompañarte al llegar a casa o para simular presencia en tu hogar.

GARDEN Time schedules

Make your outdoor luminaires turn on at a specific time to come along with you to get home or to pretend presence in your home.

JARDIN Programmations horaires

Faites en sorte que vos luminaires extérieurs s'allument à une certaine heure pour vous accompagner lorsque vous arrivez chez vous ou pour simuler une présence dans votre maison.

TC-0511-BLA



BAÑO Colorterapia

Date un capricho y benefíciate de los ambientes que puedes generar en el baño en una sesión de espuma y color.

BATH Colorthery

Indulge your whim and benefit from the atmosphere you can create in a in the bathroom in foam and color's session.

BAIN Colorothérapie

Faites-vous plaisir et profitez de l'atmosphère que vous pouvez créer dans la salle de bains lors d'une séance de mousse et de couleur.



TC-0494-BLA



COCINA Flexibilidad

Adapta la tonalidad de la luz de la cocina en función del uso que le des, luz elevada y temperatura fría, para la limpieza, o bien una luz más cálida o tenue para comer.

KITCHEN Flexibility

Changing the light's colour shade of your kitchen according to the desired usage, for cleaning, bright light and cold temperature, or a warmer or dim light, for eating.

CUISINE Flexibilité

Adaptez le ton de la lumière dans la cuisine en fonction de son utilisation : pour le nettoyage, une lumière forte et une température froide, ou une lumière plus chaude ou plus tamisée pour les repas.

Mix

MAT Aluminio
Aluminium
Aluminium

DIF Cristal
Glass
Verre



Mix es un módulo LED que requiere uno de los marcos, a escoger en las páginas 76 y 77.

Mix is a LED module that needs one of the frames, which you can choose from pages 76 and 77.

Mix est un module LED qui exige l'un des cadres, à choisir pages 76 et 77.

+INFO

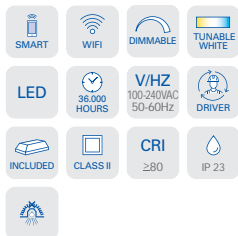

	Code	Color	Power	Kelvin	Rated flux	
S	TC-0511-BLA	○ White matt	8,4W	2700K-6000K	950 lm*	16

* Valor basado en 4000K. Value based on 4000K. Valeur basée sur 4000K.

Easy

- MAT** Aluminio
Aluminium
Aluminium
- DIF** Tecnopolímero
Technopolymer
Technopolymère

+INFO



SMART	WIFI	DIMMABLE	TUNABLE WHITE
LED	36.000 HOURS	V/HZ 100-240V 50-60Hz	LED
DRIVER	INCLUDED	CLASS II	CRI ≥80
120°	IP 23		

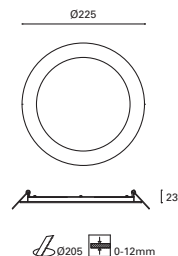

	Code	Color	Power	Kelvin	Rated flux	
S	TC-0494-BLA	○ White	17W	3000K-6000K	1675 lm*	20

Olra

- MAT** Acero
Steel
Acier
- DIF** Acrílico Opal
Opal Acrylic
Opal acrylique

+INFO



SMART	WIFI	TUNABLE WHITE	LED
36.000 HOURS	V/HZ 230V 50-60Hz	LED	DRIVER
INCLUDED	CLASS II	CRI ≥80	120°
IP 23			

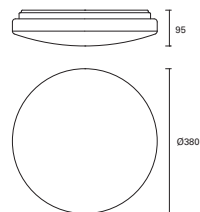

	Code	Color	Power	Kelvin	Rated flux	
S	DE-0513-BLA	○ White	23,1W	2700K-6500K	2420 lm*	10

* Valor basado en 4000K. Value based on 4000K. Valeur basée sur 4000K.

Smart Outdoor Lighting

- MAT** Polycarbonato + ABS
 Polycarbonate + ABS
 Polycarbonate + ABS
- DIF** Polycarbonato mate
 Polycarbonate matt
 Polycarbonate mat
- DIF** Polycarbonato transparente
 Transparent polycarbonate
 Polycarbonate transparent

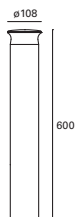

+INFO PX-0515



SMART	TUNABLE WHITE	SEASIDE SUITABLE	RGB
BLUETOOTH	LED	36.000 HOURS	VHZ 220-240V 50-60Hz
LED DRIVER	INCLUDED	CLASS II	
CRI ≥80	IP 65	IK 10	

Code	Color	Power	Kelvin	Rated flux	
S PX-0515-ANT	● Urban grey	3,3W	2700K-6000K	310 lm*	4

* Valor basado en 4000K. Value based on 4000K. Valeur basée sur 4000K.

Smart Outdoor Lighting

- MAT** Policarbonato + ABS
Polycarbonate + ABS
Polycarbonate + ABS
- DIF** Policarbonato mate
Polycarbonate matt
Polycarbonate mat
- DIF** Policarbonato transparente
Transparent polycarbonate
Polycarbonate transparent

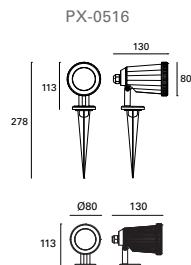

+INFO PX-0516



+INFO PX-0514



- SMART
- TUNABLE WHITE
- SEASIDE SUITABLE
- RGB
- BLUETOOTH
- LED
- 36.000 HOURS
- V/HZ
220-240V
50-60Hz
- LED DRIVER
- INCLUDED
- CLASS II
- CRI
≥80
- IP 65
- IK 10
-

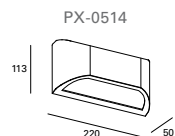

PX-0516



	Code	Size	Color	Power	Kelvin	Rated flux	
S	PX-0516-NEG	D80xH278mm	● Black	4,4W	2700K-6000K	410 lm*	16
S	PX-0514-ANT	L220xH113mm	● Urban grey	4,4W	2700K-6000K	410 lm*	12

* Valor basado en 4000K. Value based on 4000K. Valeur basée sur 4000K.



Técnico
Technical
Technique

Element

MAT Policarbonato
 Polycarbonate
 Polycarbonate

DIF Tecnopolímero
 Technopolymer
 Technopolymère

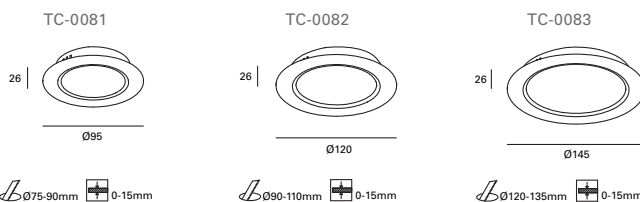

SURFACE FRAME

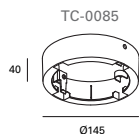
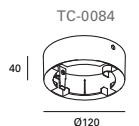

- CCT
- LED
- 36.000 HOURS
- VHZ 220-240V 50-60Hz
- INCLUDED
- CLASS II
- CRI ≥80
- 120°
- IP 23

Code	Size	Color	Power	Kelvin	Rated flux	
TC-0081-BLA	D95x26mm	○ White	4,8W	3000K, 4000K, 6000K	784 lm*	100
TC-0082-BLA	D120x26mm	○ White	9,6W	3000K, 4000K, 6000K	1600 lm*	100
TC-0083-BLA	D145x26mm	○ White	11,5W	3000K, 4000K, 6000K	1890 lm*	60

Code	Size	Description	
TC-0084-BLA	D120x40mm	Surface frame of TC-0082	100
TC-0085-BLA	D145x40mm	Surface frame of TC-0083	60

* Valor basado en 4000K. Value based on 4000K. Valeur basée sur 4000K.



3 temperaturas de color (3000K/4000K/6000K).
3 colour temperatures (3000K/4000K/6000K).
3 températures de couleur (3000K/4000K/6000K).

Easy

MAT Aluminio
Aluminium
Aluminium

DIF Acrílico
Acrylic
Acrylique



TC-0148 / TC-0149

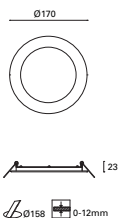

TC-0150 / TC-0151

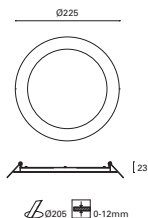

TC-0203 / TC-0204

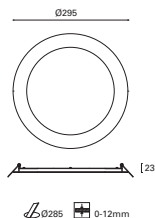

LED	36,000 HOURS	V/HZ 100-240V 50-60Hz	LED
DRIVER	INCLUDED	CLASS II	CRI ≥80
120°	✓	✓	IP 23

Code	Size	Color	Power	Kelvin	Rated flux	⊞
TC-0148-BLA	D170xH23mm	○ White	12,2W	3000K	1150 lm	40
TC-0149-BLA	D170xH23mm	○ White	12,2W	4000K	1150 lm	40
TC-0150-BLA	D225xH23mm	○ White	18,2W	3000K	1510 lm	20
TC-0151-BLA	D225xH23mm	○ White	18,2W	4000K	1510 lm	20
TC-0203-BLA	D295xH23mm	○ White	22W	3000K	2160 lm	10
TC-0204-BLA	D295xH23mm	○ White	22W	4000K	2160 lm	10

MAT

Aluminio
Aluminium
Aluminium

DIF

Acrílico
Acrylic
Acrylique



TC-0154 / TC-0155

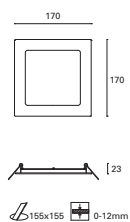

TC-0156 / TC-0157

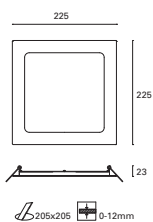

TC-0212 / TC-0213

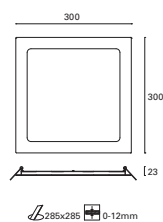

LED	36.000 HOURS	V/HZ 100-240V 50-60Hz	LED
DRIVER	INCLUDED	CLASS II	CRI ≥80
120°	√	IP 23	18

Code	Size	Color	Power	Kelvin	Rated flux	⊞
TC-0154-BLA	L170xH23mm	○ White	12,2W	3000K	1150 lm	40
TC-0155-BLA	L170xH23mm	○ White	12,2W	4000K	1150 lm	40
TC-0156-BLA	L225xH23mm	○ White	18,2W	3000K	1510 lm	20
TC-0157-BLA	L225xH23mm	○ White	18,2W	4000K	1510 lm	20
TC-0212-BLA	L300xH23mm	○ White	22W	3000K	2160 lm	10
TC-0213-BLA	L300xH23mm	○ White	22W	4000K	2160 lm	10

Jet

MAT Aluminio
 Aluminium
 Aluminium

DIF Poliestireno
 Polystyrene
 Polystyrène



TC-0000 / TC-0001

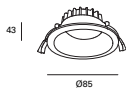

TC-0002 / TC-0003

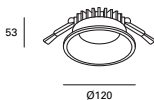

TC-0004 / TC-0005

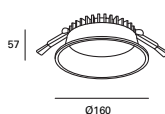

TC-0006 / TC-0007

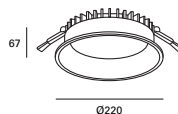

-
-
-
-
-
-
-
-
-
-
-
-

Code	Size	Color	Power	Kelvin	Rated flux	
TC-0000-BLA	D85xH43mm	○ White	7W	3000K	720 lm	50
TC-0001-BLA	D85xH43mm	○ White	7W	4000K	720 lm	50
TC-0002-BLA	D120xH53mm	○ White	10,1W	3000K	1020 lm	40
TC-0003-BLA	D120xH53mm	○ White	10,1W	4000K	1020 lm	40
TC-0004-BLA	D160xH57mm	○ White	20,3W	3000K	2135 lm	20
TC-0005-BLA	D160xH57mm	○ White	20,3W	4000K	2135 lm	20
TC-0006-BLA	D220xH67mm	○ White	29,5W	3000K	3300 lm	20
TC-0007-BLA	D220xH67mm	○ White	29,5W	4000K	3300 lm	20



Hide

MAT Aluminio
 Aluminium
 Aluminium

DIF Cristal
 Glass
 Verre

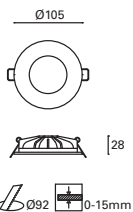

- LED**
- 35,000 HOURS
- V/HZ
100-240V
50-60Hz
- LED
- DRIVER
- INCLUDED
- CLASS II
- CRI
≥20
- CONFORT VISUAL
- 130°
- √
- IP 44
-

Code	Size	Color	Power	Kelvin	Rated flux	
TC-0175-BLA	D105xH28mm	○ White	7,8W	3000K	890 lm	20
TC-0215-BLA	D105xH28mm	○ White	7,8W	4000K	890 lm	20
TC-0176-BLA	D105xH28mm	○ White	10,9W	3000K	1150 lm	20
TC-0216-BLA	D105xH28mm	○ White	10,9W	4000K	1150 lm	20

Wide

MAT

Aluminio
Aluminium
Aluminium

DIF

Polycarbonato
Polycarbonate
Polycarbonate



TC-0503 / TC-0504

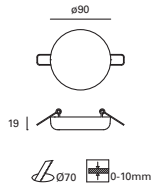

TC-0505 / TC-0506

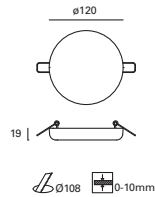

LED	36.000 HOURS	V/HZ 100-240V 50-60Hz	LED
DRIVER	INCLUDED	CLASS II	CRI ≥80
120°	√	IP 54	LED

	Code	Size	Color	Power	Kelvin	Rated flux	⊞
S	TC-0503-BLA	D90xH19mm	○ White	9,5W	3000K	1100 lm	40
S	TC-0504-BLA	D90xH19mm	○ White	9,5W	4000K	1100 lm	40
S	TC-0505-BLA	D120xH19mm	○ White	17,4W	3000K	2000 lm	40
S	TC-0506-BLA	D120xH19mm	○ White	17,4W	4000K	2000 lm	40

Bala

- MAT** Aluminio
Aluminium
Aluminium
- DIF** Policarbonato
Polycarbonate
Polycarbonate

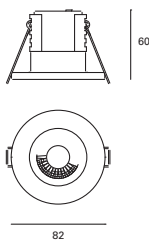

Ø57 0-35mm

- PHASE CUT
- LED
- 36,000 HOURS
- V/HZ 220-240V 50-60Hz
- LED DRIVER
- INCLUDED
- CLASS II
- CRI ≥80
- 60°
- ✓
- IP 65
- Light beam icon

Code	Size	Color	Power	Kelvin	Rated flux	☐
TC-0440-BLA	D82xH60mm	○ White	5,2W	3000K	510 lm	20
TC-0472-BLA	D82xH60mm	○ White	8,9W	3000K	850 lm	20
S TC-0491-BLA	D82xH60mm	○ White	8,9W	2700K	810 lm	20



Base

MAT Aluminio
 Aluminium
 Aluminium

DIF Cristal
 Glass
 Verre

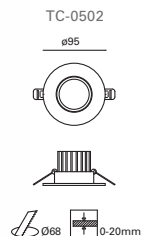
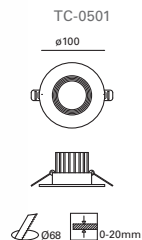

LED 36,000 HOURS V/HZ 100-240V 50-60Hz (LED)

DRIVER INCLUDED CLASS II CRI ≥80

40° 0° 20

TC-0501

CONFORT VISUAL IP 54

TC-0502

IP 23 45°

	Code	Size	Color	Power	Kelvin	Rated flux	⊞
S	TC-0501-BLA	D100xH52mm	○ White	7W	3000K	820 lm	20
	TC-0502-BLA	D95xH52mm	○ White	7W	3000K	820 lm	20



Dorit

MAT Aluminio
 Aluminium
 Aluminium

DIF Cristal
 Glass
 Verre



TC-0349

Ø140



95

⊕ Ø120 ⊞ 0-12mm

TC-0350

Ø165



115

⊕ Ø150 ⊞ 0-12mm

- LED
- 36,000 HOURS
- V/HZ
100-240V
50-60Hz
- LED
- DRIVER
- INCLUDED
- CLASS II
- CRI
≥80
- COMFORT VISUAL
- 60°
- IP 44
- IP 44
-

Code	Size	Color	Power	Kelvin	Rated flux	
TC-0349-BLA	D140xH95mm	○ White	15,7W	3000K	1530 lm	18
TC-0350-BLA	D165xH115mm	○ White	18,7W	3000K	2300 lm	12



Mode

MAT Polycarbonato
 Polycarbonate
 Polycarbonate

DIF Polycarbonato
 Polycarbonate
 Polycarbonate

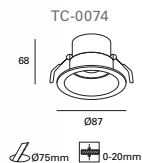
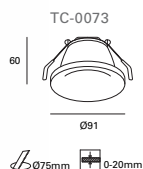
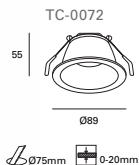

- LED**
- 36,000 HOURS
- V/HZ 100-240V 50-60HZ
- CLASS II
- CRI ≥90
- CONFORT VISUAL
- UGR <16
- 30°
- IP 23

TC-0074



Code	Size	Color	Power	Kelvin	Rated flux	☼
TC-0072-BLA	D89xH55mm	○ White	5,4W	3000K	605 lm	48
TC-0073-BLA	D91xH60mm	○ White	5,4W	3000K	605 lm	48
TC-0074-BLA	D87xH68mm	○ White	5,4W	3000K	605 lm	48



Efecto iluminación de la colección.
Lighting effect of the collection.
Effet de lumière de la collection.

Jim NEW

- MAT** Aluminio
Aluminium
Aluminium
- DIF** Policarbonato
Polycarbonate
Polycarbonate

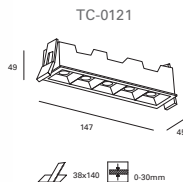
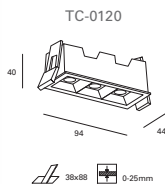
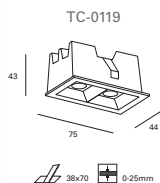
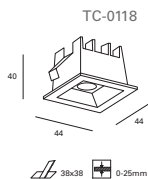

+INFO



PRO	LED	36.000 HOURS	VHZ 220-240V 50-60HZ
LED	DRIVER	INCLUDED	CLASS II
CRI ≥80	COMFORT VISUAL	UGR <16	30°
IP 23			

Code	Size	Color	Power	Kelvin	Rated flux	☒
TC-0118-BLA	L44xH40mm	○ White	2,3W	3000K	170 lm	100
TC-0119-BLA	L75xH43mm	○ White	3,9W	3000K	340 lm	100
TC-0120-BLA	L94xH40mm	○ White	5,6W	3000K	510 lm	50
TC-0121-BLA	L147xH49mm	○ White	10,3W	3000K	850 lm	50



Cardan

MAT Acero
 Steel
 Acier

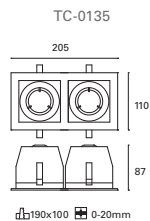
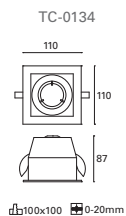

Compatible con módulo
 MIX TC-0070, TC-0071 (p. 76)

Compatible with module
 MIX TC-0070, TC-0071 (p. 76)

Compatible avec le module
 MIX TC-0070, TC-0071 (p. 76)



Code	Size	Color	Power	
TC-1400-BLA	L110xH87mm	○ White	Max. 8W (LED)	32
TC-1401-BLA	L205xH87mm	○ White	2x Max. 8W (LED)	16

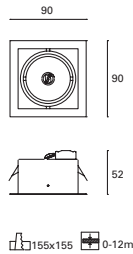

Code	Size	Color	Power	
TC-1500-BLA	L90xH52mm	○ White	Max. 15W (LED)	12

Sicro NEW

MAT
 Aluminio
 Aluminium
 Aluminium

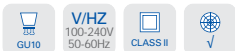
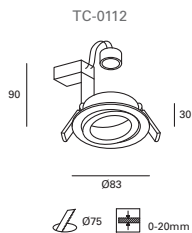
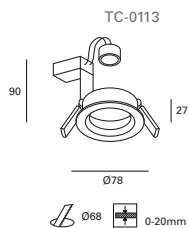

TC-0113



TC-0112



Code	Size	Color	Power	☒
TC-0113-BLA	D78xH90mm	○ White	Max. 8W (LED)	100
TC-0113-NEG	D78xH90mm	○ White	Max. 8W (LED)	100
TC-0112-BLA	D83xH90mm	○ White	Max. 8W (LED)	100
TC-0112-NEG	D83xH90mm	○ White	Max. 8W (LED)	100



Sound Plus

MAT Aluminio
 Aluminium
 Aluminium

DIF Cristal
 Glass
 Verre

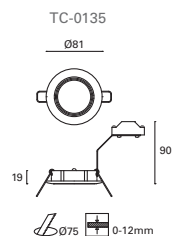
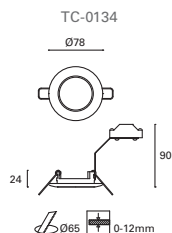

GU10
 V/Hz 100-240V 50-60Hz
 CLASS II
 V

IP 23

TC-0135

30°

Code	Size	Color	Power	
TC-0134-BLA	D78xH90mm	○ White	Max. 8W (LED)	100
TC-0135-BLA	D81xH90mm	○ White	Max. 8W (LED)	100





Minor

MAT Aluminio
 Aluminium
 Aluminium

DIF Cristal
 Glass
 Verre

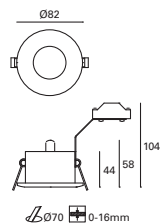

Code	Color	Power	⊞
TC-1200-BLA	○ White	Max. 8W (LED)	50

Feu NEW

- MAT** Aluminio
Aluminium
Aluminium
- DIF** Cristal
Glass
Verre

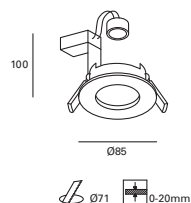

+INFO



- GU10
- V/Hz
100-240V
50-60Hz
- CLASS II
-
- IP 65
-

Code	Color	Power	
DE-0129-CRO	● Chrome finish	Max. 8W (LED)	50
DE-0129-BLA	○ White	Max. 8W (LED)	50
DE-0129-NEG	● Black	Max. 8W (LED)	50

Ter NEW

MAT Aluminio
 Aluminium
 Aluminium

DIF Cristal
 Glass
 Verre

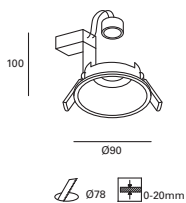

+INFO



Code	Color	Power	
DE-0130-BLA	○ White	Max. 8W (LED)	50
DE-0130-NEG	● Black	Max. 8W (LED)	50

Rame NEW

MAT Aluminio
Aluminium
Aluminium

DIF Cristal
Glass
Verre

+INFO

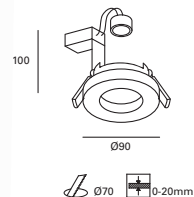

Code	Color	Power	
DE-0128-CRO	● Chrome finish	Max. 8W (LED)	50

Lab NEW

MAT Aluminio
Aluminium
Aluminium

DIF Cristal
Glass
Verre

+INFO

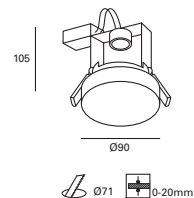

Code	Color	Power	
DE-0132-BLA	○ White finish	Max. 8W (LED)	50



Easy Surface

- MAT** Aluminio
Aluminium
Aluminium
- DIF** Acrílico
Acrylic
Acrylique



TC-0160 / TC-0161



TC-0162 / TC-0163

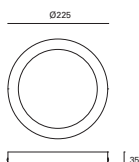

TC-0415 / TC-0416

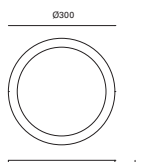

TC-0411 / TC-0412

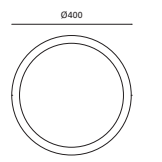

- LED**
- 36.000 HOURS**
- V/HZ**
100-240V
50-60Hz
- LED**
- DRIVER**
- INCLUDED**
- CLASS II**
- CRI**
≥80
- 120°**
- √**
- IP 23**

Code	Size	Color	Power	Kelvin	Rated flux	⊞
TC-0160-BLA	D170xH35mm	○ White	12,2W	3000K	1150 lm	20
TC-0161-BLA	D170xH35mm	○ White	12,2W	4000K	1150 lm	20
TC-0162-BLA	D225xH35mm	○ White	18,2W	3000K	1510 lm	20
TC-0163-BLA	D225xH35mm	○ White	18,2W	4000K	1510 lm	20
TC-0415-BLA	D300xH35mm	○ White	24W	3000K	2590 lm	10
TC-0416-BLA	D300xH35mm	○ White	24W	4000K	2720 lm	10
TC-0411-BLA	D400xH35mm	○ White	29,3W	3000K	3375 lm	5
TC-0412-BLA	D400xH35mm	○ White	29,3W	4000K	3375 lm	5

Easy Surface

MAT Aluminio
 Aluminium
 Aluminium

DIF Acrílico
 Acrylic
 Acrylique



TC-0166 / TC-0167

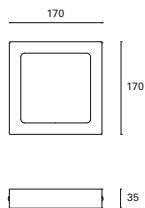

TC-0168 / TC-0169

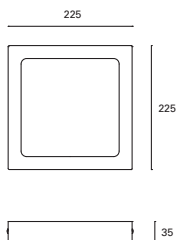

TC-0413 / TC-0414

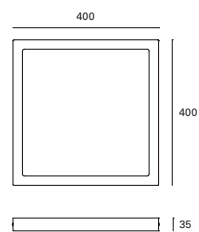

- LED**
- 36.000 HOURS
- V/HZ
100-240V
50-60Hz
- LED
- DRIVER
- INCLUDED
- CLASS II
- 120°
- CRI
≥80
- IP 23

Code	Size	Color	Power	Kelvin	Rated flux	⊞
TC-0166-BLA	L170xH35mm	○ White	12,2W	3000K	1150 lm	20
TC-0167-BLA	L170xH35mm	○ White	12,2W	4000K	1150 lm	20
TC-0168-BLA	L225xH35mm	○ White	18,2W	3000K	1510 lm	20
TC-0169-BLA	L225xH35mm	○ White	18,2W	4000K	1510 lm	20
TC-0413-BLA	L400xH35mm	○ White	29,3W	3000K	3813 lm	5
TC-0414-BLA	L400xH35mm	○ White	29,3W	4000K	4106 lm	5



Fox

- MAT** Aluminio
Aluminium
Aluminium
- DIF** Policarbonato
Polycarbonate
Polycarbonate

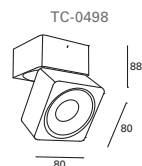
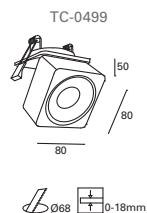

- LED
- 35,000 HOURS
- V/HZ 100-240V 50-60HZ
- LED
- DRIVER
- INCLUDED
- CLASS II
- CRI ≥80
- CONFORT VISUAL
- 30°
- √
- 340°
- 90°
- IP 20

TC-0499



	Code	Size	Color	Power	Kelvin	Rated flux	⊞
S	TC-0499-BLA	L80xH50mm	○ White	8,8W	3000K	670 lm	8
S	TC-0498-BLA	L80xH88mm	○ White	8,8W	3000K	670 lm	8



Fab NEW

MAT Aluminio
 Aluminium
 Aluminium

DIF Cristal
 Glass
 Verre

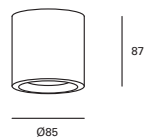

+INFO



GU10
 VHZ 100-240V 50-60Hz
 CLASS II
 V

IP 65

Code	Color	Power	
DE-0131-BLA	○ White	Max. 8W (LED)	50
DE-0131-NEG	● Black	Max. 8W (LED)	50



Mix NEW

MAT Aluminio
Aluminium
Aluminium

DIF Cristal
Glass
Verre

TC-0070 / TC-0511



TC-0071



TC-0511



Code	Size	Color	Power	K	lm	
TC-0070-BLA	D58xH57mm	○ White matt	6,2W	3000,4000 y 5000K	900 lm*	16
N TC-0070-NEG	D58xH57mm	● Black	6,2W	3000,4000 y 5000K	900 lm*	16
TC-0511-BLA	D58xH57mm	○ White matt	8,4W	2700K-6000K	950 lm*	16
TC-0071-BLA	D58xH96mm	○ White matt	11,2W	3000,4000 y 5000K	1624 lm*	20
N TC-0071-NEG	D58xH96mm	● Black	11,2W	3000,4000 y 5000K	1624 lm*	20



TC-1900



IP 54

TC-1901



20°

TC-0111



IP 20

TC-0476



IP 23

Code	Color	Short description	
TC-1900-BLA	○ White matt	ROUND FIXED	100
N TC-1900-NEG	● Black	ROUND FIXED	100
TC-1901-BLA	○ White matt	ROUND ADJUSTABLE	100
N TC-1901-NEG	● Black	ROUND ADJUSTABLE	100
N TC-0111-BLA	○ White matt	SQUARE FIXED	100
N TC-0476-BLA	○ White matt	ROUND DEEP	100



TC-1900 +**

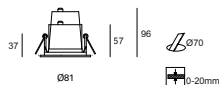

TC-1901 +**

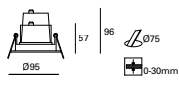

TC-0111 +**

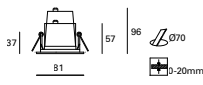

TC-0476 +**

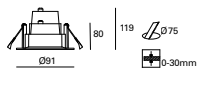

* Valor basado en 4000K. Value based on 4000K. Valeur basée sur 4000K.

** TC-0070, TC-0511, TC-0071 o/or/ou TC-0366.

*** TC-0070, TC-0511 o/or/ou TC-0366.



Code	Color	Power	Box
TC-0366-BLA	○ White matt	Max. 8W (LED)	50
N TC-0366-NEG	● Black	Max. 8W (LED)	50



TC-0200



TC-0303



TC-0220



TC-0304



Code	Color	Short description	Box
TC-0200-BLA	○ White matt	ROUND VISUAL COMFORT	100
TC-0303-BLA	○ White matt	VISUAL COMFORT ADJUSTABLE	50
TC-0220-BLA	○ White matt	ROUND IP65	50
N TC-0220-NEG	● Black	ROUND IP65	50
TC-0304-BLA	○ White matt	SURFACE	25

* No es compatible con TC-0071. Not compatible with TC-0071. Non compatible avec TC-0071.



TC-0200 +**



TC-0303 +**



TC-0220 +**

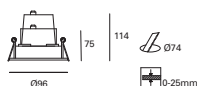

TC-0304 +**



Stac NEW

- MAT** Aluminio
Aluminium
Aluminium
- DIF** Policarbonato
Polycarbonate
Polycarbonate

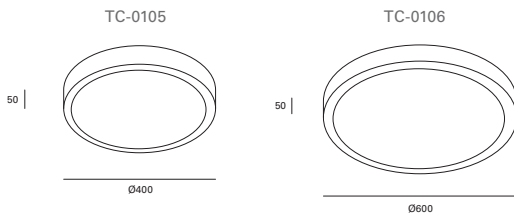

+INFO



- PRO**
- LED**
- 96,000 HOURS
- VHZ 220-240V 50-60Hz
- LED DRIVER
- INCLUDED
- CLASS 1
- CRI ≥80
- CONFORT VISUAL <22
- UGR 120°
- IP 20

Code	Size	Color	Power	Kelvin	Rated flux	
TC-0105-BLA	D400xH50mm	○ White	18,3W	4000K	2550 lm	10
TC-0106-BLA	D600xH50mm	○ White	42W	4000K	4500 lm	5

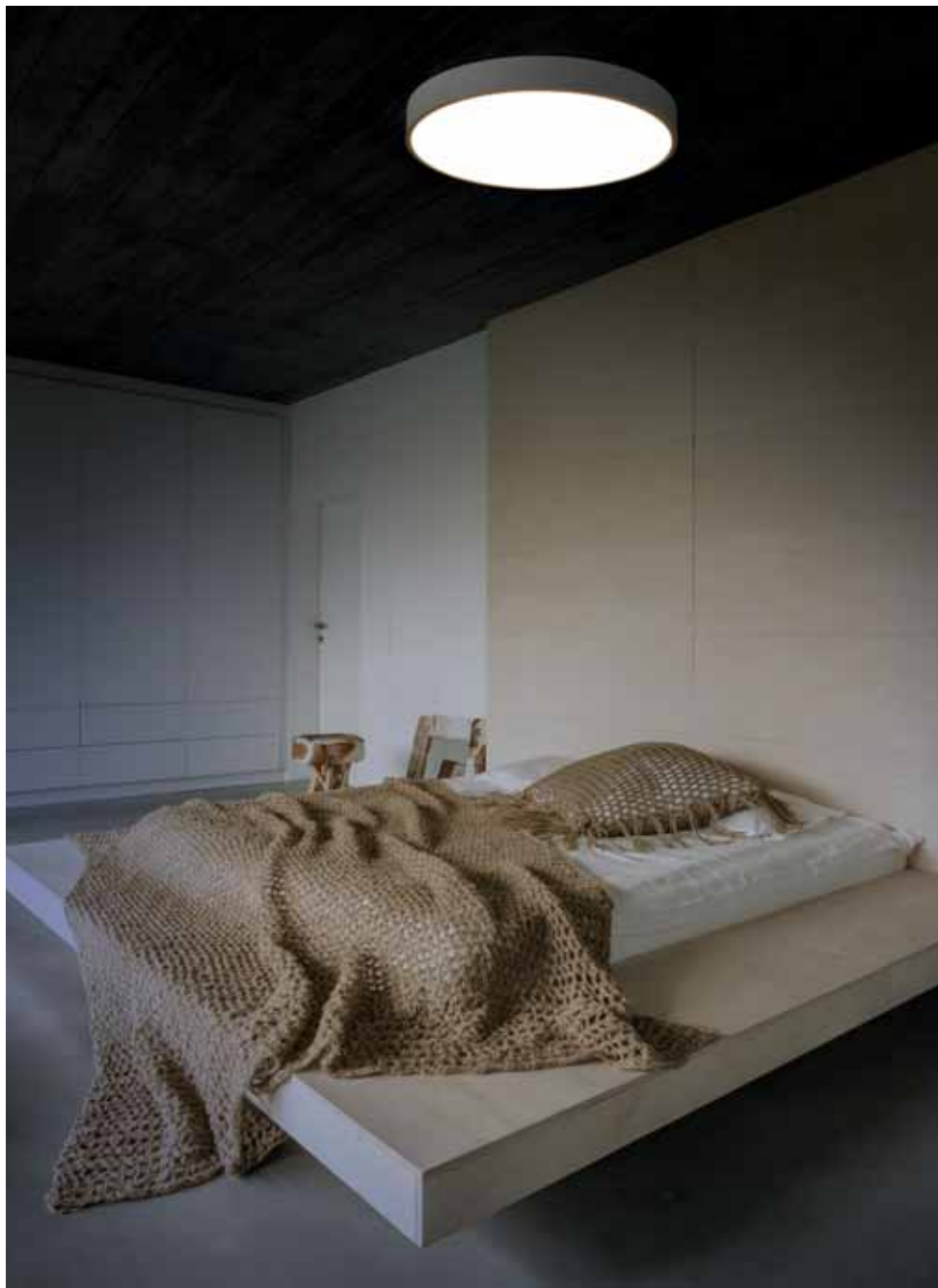

Ilo

MAT Aluminio
 Aluminium
 Aluminium

DIF Acrílico
 Acrylic
 Acrylique



UNION KIT



TC-0454



CONNECTION BOX



TC-0452

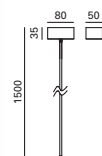

TC-0450 / TC-0451

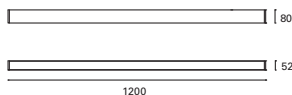

SUSPENSION KIT



TC-0453



Code	Size	Color	Power	Kelvin	Rated flux	⊞
TC-0450-BLA	L1200xH80mm	○ White	27,9W	3000K	2635 lm	6
TC-0451-BLA	L1200xH80mm	○ White	27,9W	4000K	2635 lm	6
S TC-0451-GRI	L1200xH80mm	● Grey	27,9W	4000K	2635 lm	6

Code	Color	Short description	⊞
TC-0454-SIN	-	Lineal union kit	6
TC-0452-BLA	○ White	Connection box	6
S TC-0452-GRI	● Grey	Connection box	6
TC-0453-SIN	-	1500mm adjustable suspension kit	6

LED
 36.000 HOURS
 V/HZ 100-277V 50-60Hz
 (LED)

DRIVER INCLUDED SERIAL INSTALLATION CLASS I

CRI ≥80 IP 20



Pop

- MAT** ABS
ABS
ABS
- DIF** Policarbonato
Polycarbonate
Polycarbonate



 Instalación con conector rápido.
 Installation with quick connector.
 Installation avec connecteur rapide.

- PRO**
- LED**
- 36,000 HOURS
- V/HZ 220-240V 50-60Hz
- LED
- INCLUDED
- SERIAL INSTALLATION
- CLASS II
- CRI ≥80
- 120°
- IP 65
- IK 09

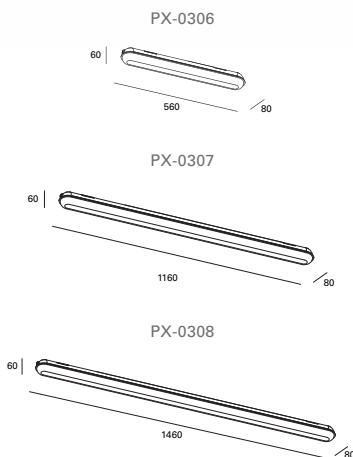

Code	Size	Color	Power	Kelvin	Rated flux	
PX-0306-GRI	L560xH60mm	● Grey	16,7W	4000K	2588 lm	15
PX-0307-GRI	L1160xH60mm	● Grey	35,4W	4000K	4879 lm	12
PX-0308-GRI	L1460xH60mm	● Grey	44W	4000K	6426 lm	8



Tent

- MAT** Aluminio
Aluminium
Aluminium
- DIF** Policarbonato
Polycarbonate
Polycarbonate



★
 Dos reflectores (spot y flood) incluidos.
 Two reflectors (spot and flood) included.
 Deux réflecteurs (spot et flood) inclus.

★
 Compatible con carril trifásico.
 No compatible con TC-0473-BLA.
 Compatible with triple PhaseTrack.
 Not compatible with TC-0473-BLA.
 Compatible avec rail triphasé.
 Non compatible avec TC-0473-BLA

TC-0046 / TC-0047

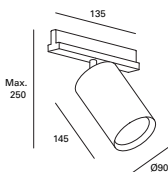

PRO	LED	36.000 HOURS	V/HZ 220-240V 50-60Hz
INCLUDED	CLASS II	CRI ≥90	CONFORT VISUAL
UGR <16	15°	24°	V
350°	45°		

Code	Color	Power	Kelvin	Rated flux	⊞
TC-0046-BLA	○ White	27,5W	3000K	2930 lm	24
TC-0046-NEG	● Black	27,5W	3000K	2930 lm	24
TC-0047-BLA	○ White	27,5W	4000K	3110 lm	24
TC-0047-NEG	● Black	27,5W	4000K	3110 lm	24



Arch

- MAT** Aluminio
Aluminium
Aluminium
- DIF** Policarbonato
Polycarbonate
Polycarbonate



Compatible con carril trifásico.
 No compatible con TC-0473-BLA.
 Compatible with triple phase Track.
 Not compatible with TC-0473-BLA.
 Compatible avec rail triphasé.
 Non compatible avec TC-0473-BLA.

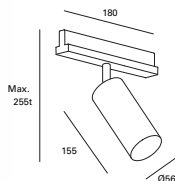

PRO	LED	38.000 HOURS	VHZ 220-240V 50-60Hz
INCLUDED	CLASS II	CRI ≥90	24°
√	350°	45°	IP 20

Code	Color	Power	Kelvin	Rated flux	☒
TC-0076-BLA	○ White	20,6W	3000K	2223 lm	30

Key

- MAT** Aluminio
Aluminium
Aluminium
- DIF** Cristal
Glass
Verre



Compatible con carril trifásico.
 No compatible con TC-0473-BLA.
 Compatible with triple Phase Track.
 Not compatible with TC-0473-BLA.
 Compatible avec rail triphasé.
 Non compatible avec TC-0473-BLA.

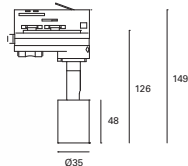

GU10	VHZ 100-240V 50-60Hz	CLASS I	355°
90°	IP 20		

Code	Color	Power	☒
S TC-0485-BLA	○ White	Max. 8W (LED)	50





Cone

MAT Acero
 Steel
 Acier



Compatible con carril monofásico
 (TC-0437-BLA).
 Proyector PAR-30 LED.

Compatible with single Phase Track
 (TC-0437-BLA).
 PAR-30 LED spotlight.

Compatible avec rail monophasé
 (TC-0437-BLA).
 Projecteur PAR-30.

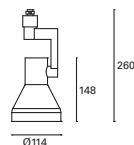

	Code	Color	Power	
S	TC-0316-BLA	○ White	Max. 15W (LED)	20

Accessory



TC-8003



TC-8004

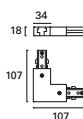

TC-0473

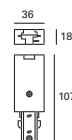
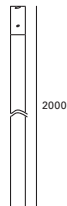

Code	Color	Description	
TC-8003-BLA	○ White	Lineal connector	100
TC-8004-BLA	○ White	"L" connector	5
TC-0473-BLA	○ White	Single-phase track + End cap + Mains connector.	10

Square eco

MAT Acero y Aluminio
 Steel and Aluminium
 Acier et Aluminium

DIF Tecnopolímero
 Technopolymer
 Technopolymère

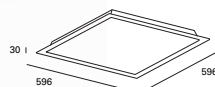

Substitución directa placas tipo armstrong
 Directly replacing armstrong ceiling units

PRO	LED	36.000 HOURS	V/HZ 220-240V 50-60Hz
DRIVER	INCLUDED	CLASS II	CRI ≥80
UGR <22	120°	√	IP 23

Code	Color	Power	Kelvin	Rated flux	
TC-0075-BLA	○ White	39W	4000K	4400 lm	4

Square

MAT Aluminio
 Aluminium
 Aluminium

DIF Tecnopolímero
 Technopolymer
 Technopolymère

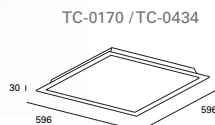

Substitución directa placas tipo armstrong
 Directly replacing armstrong ceiling units

SURFACE FRAME

TC-0202

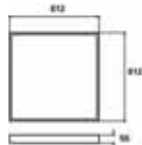

LED	36.000 HOURS	V/HZ 100-240V 50-60Hz	LED
DRIVER	INCLUDED	CLASS II	CRI ≥80
UGR <22	120°	√	IP 40

	Code	Color	Power	Kelvin	Rated flux	
S	TC-0170-BLA	○ White matt	40,9W	4000K	4550 lm	5
S	TC-0434-BLA	○ White matt	40,9W	3000K	4375 lm	5

	Code	Color	Description	
S	TC-0202-BLA	○ White matt	Surface frame for TC-0170, TC-0434 and TC-0075	5





Solar

Forlight Solar

Zero

consumption

La **energía solar** es un tipo de energía renovable inagotable; genera poca contaminación y es amigable con el medio ambiente. Preservar y cuidar el entorno que nos rodea es responsabilidad de todos y así lo es para nosotros, desde **Forlight** presentamos una nueva colección de lámparas solares que son ideales para ser utilizadas en espacios abiertos y cerrados, su instalación es de bajo riesgo porque no necesita cableado. Además, gracias a la inteligente combinación de nuestros paneles de alta eficiencia con potentes módulos leds, damos una luz satisfactoria sin consumir electricidad alguna.

Nuestro **DECO** portátil ilustra una movilidad ligera, agradable y omnipresente de usar.

Nuestra gama **top and bow** que está formado por los apliques y bolardos, está construida por un sistema de panel solar integrado, rápido y fácil de instalar. Dispone de funcionalidades que permite aprovechar al máximo la energía solar disponible gracias al uso de atenuadores, **temporizadores y sensores PIR de 3 pasos**. Y finalmente, con nuestro nuevo proyector **Lis** pretendemos generar calidez y seguridad al espacio iluminado, con puntos de luz múltiples para una repartición homogénea de la luminosidad, y un sensor crepuscular incorporado para una activación automática cuando el entorno lo reclama.

Solar energy is a type of endless renewable energy: it generates little pollution and is environmentally friendly. Preserving and caring for the environment that surrounds us is everyone's responsibility and so it is for us, from Forlight we present a new collection of solar lamps that are ideal for use both in open and closed spaces, it's low risk installation because there is no electrical wiring needed. In addition, thanks to the intelligent combination of our high efficiency panels with powerful led modules, we provide a satisfactory level of light without consuming any electricity.

Our portable **DECO** illustrates a light mobility, it is pleasant and ubiquitous to use.

Our product line, **top and bow**, which is made up of wall lamps and bollards, is built by an integrated solar panel system, quick and easy to install. It has features that allow you to make the maximum use of available solar energy thanks to the use of dimmers, **timers and 3-step PIR sensors**. And finally, with our new spotlight **Lis** we seek to generate warmth and security to the illuminated space, with multiple points of light for a homogeneous distribution of luminosity, and a built-in twilight sensor for automatic activation when the environment demands it.

L'énergie solaire est un type d'énergie renouvelable inépuisable ; elle produit peu de pollution et est respectueuse de l'environnement. Préserver et prendre soin de l'environnement qui nous entoure est la responsabilité de chacun et il en est de même pour nous. Chez **Forlight**, nous présentons une nouvelle collection de lampes solaires idéales pour être utilisées dans des espaces ouverts et fermés, leur installation présente peu de risques car aucun câblage n'est nécessaire. De plus, grâce à la combinaison intelligente de nos panneaux à haut rendement avec de puissants modules LED, nous fournissons un niveau d'éclairage satisfaisant sans consommer d'électricité.

Notre **DECO** portable illustre une mobilité légère, agréable et omniprésente à utiliser.

Notre gamme **Top et Bow**, qui comprend des appliques murales et des bornes, est construite avec un système de panneaux solaires intégré, rapide et facile à installer. Elle possède des fonctionnalités qui permettent de tirer le meilleur parti de l'énergie solaire disponible grâce à l'utilisation de gradateurs, **de minuteurs et de capteurs PIR à 3 niveaux**. Enfin, avec notre nouveau projecteur **Lis**, nous cherchons à créer de la chaleur et de la sécurité dans l'espace éclairé, avec plusieurs points lumineux pour une distribution homogène de la luminosité, et un capteur crépusculaire intégré pour une activation automatique lorsque l'environnement l'exige.



Automáticas
Automatic
Automatique



Ecológicas y sostenibles
Ecological and sustainable
Écologique et durable



Más seguridad
More security
Plus de sécurité



Gran autonomía
Great autonomy
Grande autonomie



Flexibilidad para
Montarlas o Cambiarlas
de Sitio
Flexibility for mounting
or relocation
Flexibilité de montage
ou de déplacement



No necesitan
instalación eléctrica
No electrical
installation required
Aucune installation
électrique requise



Reduce el consumo
eléctrico
Reduce electricity
consumption
Réduit la consommation
d'électricité



Lis NEW

MAT PC y Acero inoxidable
PC and Stainless steel
PC et Acier inoxydable

DIF Policarbonato
Polycarbonate
Polycarbonate

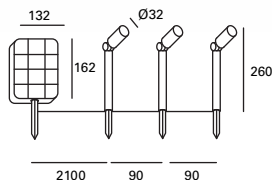

+INFO

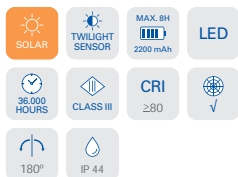

Code	Color	Power	K	lm	☒
PX-0451-NEG	● Black	3W	3000K	300 lm	4



Top

- MAT** Aluminio Aluminium Aluminium
- DIF** Vidrio templado Tempered glass Verre trempé

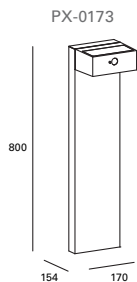
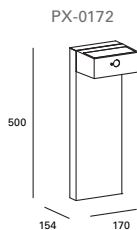
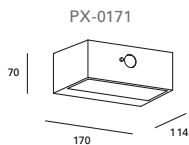

+INFO PX-0171



+INFO PX-0172



+INFO PX-0173



Code	Size	Color	Power	Kelvin	Rated flux	☒
PX-0171-ANT	H70xL170mm	● Urban grey	3W	3000K	400 lm	16
PX-0172-ANT	H500xL170mm	● Urban grey	3W	3000K	400 lm	4
PX-0173-ANT	H800xL170mm	● Urban grey	3W	3000K	400 lm	4



Bow

MAT

Aluminio
Aluminium
Aluminium

DIF

Policarbonato
Polycarbonate
Polycarbonate



PX-0174

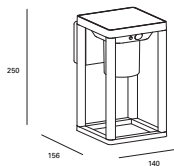

PX-0176

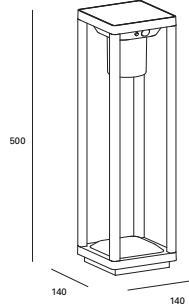

+INFO PX-0174



+INFO PX-0176



Code	Size	Color	Power	Kelvin	Rated flux	
PX-0174-ANT	H250xL140mm	● Urban grey	3W	3000K	400 lm	12
PX-0176-ANT	H500xL140mm	● Urban grey	3W	3000K	400 lm	6



Deco

MAT

Acero
Steel
Acier

DIF

Polycarbonato
Polycarbonate
Polycarbonate

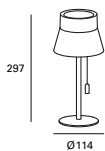

Tirador para ajustar niveles de luminosidad.

Handle to adjust brightness levels.

Poignée permettant de régler les niveaux de luminosité.

+INFO



Code	Color	Power	Kelvin	Rated flux	⊞
PX-0263-NEG	● Black	2,8W	3000K	280 lm	8





Exterior
Outdoor
Extérieur

Up NEW

MAT Aluminio
 Aluminium
 Aluminium

DIF Policarbonato
 Polycarbonate
 Polycarbonate

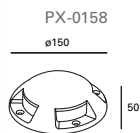
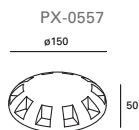

+INFO



- LED
- 36.000 HOURS
- V/Hz 220-240V 50-60Hz
- LED
- DRIVER
- INCLUDED
- SERIAL INSTALLATION
- CLASS I
- CRI ≥80
- IP 65
- IK 10
- 0,3 M

Code	Size	Color	Power	Kelvin	Rated flux	
N PX-0557-ANT	D150xH50mm	● Urban grey	10,6W	3000K	870 lm	16
PX-0158-ANT	D150xH50mm	● Urban grey	10,6W	3000K	870 lm	16



Incasso NEW

MAT Acero inoxidable AISI 304
 Stainless steel AISI 304
 Acier inoxydable AISI 304

DIF Cristal
 Glass
 Verre

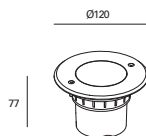

PRO	LED	36,000 HOURS	V/HZ 100-240VAC 50-60Hz
INCLUDED	CLASS I	CRI ≥80	30°
↓	IP 65/67	IK 10	0.25 M
INCLUDED			

Code	Color	Power	Kelvin	Rated flux	⊞
PX-0520-INO	● Stainless steel	6,2W	3000K	500 lm	8



Ringo

MAT Acero inoxidable AISI 304
 Stainless steel AISI 304
 Acier inoxydable AISI 304

DIF Cristal
 Glass
 Verre

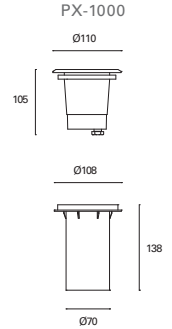

V/HZ 100-240V 50-60Hz
CLASS I
UGR <22
IP 65/67
IK 10
0,25 M
INCLUDED

Code	Color	Power	
PX-1000-INO	● Stainless steel	Max.8W (LED)	12

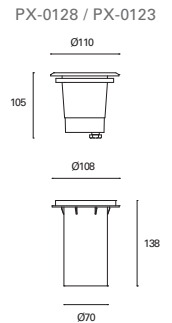

LED
36,000 HOURS
V/HZ 100-240V 50-60Hz
INCLUDED
CLASS I
CRI ≥80
20°
IP 65/67
IK 10
0,25 M
INCLUDED

Code	Color	Power	Kelvin	Rated flux	
PX-0128-INO	● Stainless steel	3,5W	3000K	370 lm	12
PX-0123-INO	● Stainless steel	3,5W	4000K	420 lm	12



PX-0355

Ø155

Ø98



109



Ø180

LED	36,000 HOURS	V/HZ 100-240V 50-60Hz	INCLUDED
LED	DRIVER	INCLUDED	CLASS 1
CRI ≥80	20°	√	IP 65/67
IK 04	0,3 M	INCLUDED	

Code	Size	Color	Power	Kelvin	Rated flux	
PX-0355-INO	D155xL109mm	● Stainless steel	10,1W	3000K	1280 lm	12

Tidian

MAT

Tecnopolímero
 Technopolymer
 technopolymère

DIF

Cristal
 Glass
 Verre

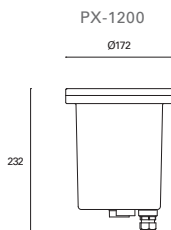
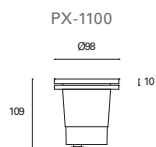

V/HZ
 100-240V
 50-60Hz



PX-1100



PX-1200



Code	Color	Power	⊞
PX-1100-NEG	● Black	Max. 8W (LED)	12
PX-1200-NEG	● Black	Max. 15W (LED)	6



Pixa NEW

MAT

Acero inoxidable AISI202
 Stainless steel AISI202
 Acier inoxydable AISI202

DIF

Cristal
 Glass
 Verre



Otra posibilidad.
 Another possibility.
 Autre possibilité.

+INFO

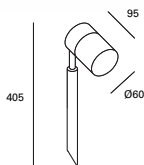

V/HZ 100-240V 50-60Hz CLASS I

90°

350°

IP 44 IK 06 INCLUDED

0,36 M

Code	Color	Power	
PX-0533-NEG	● Black	Max. 8W (LED)	16



Hit

MAT

Aluminio
Aluminium
Aluminium

DIF

Cristal
Glass
Verre

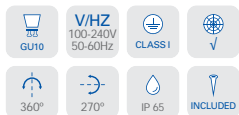
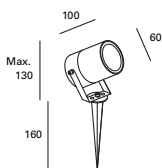

Code	Color	Power	
PX-0360-NEG	● Black	Max. 8W (LED)	20



Icaro

MAT

Aluminio
Aluminium
Aluminium

DIF

Cristal
Glass
Verre

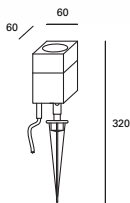

Code	Color	Power	
PX-0150-GRI	● Grey	Max. 8W (LED)	8



Jumbo

MAT

Polycarbonato + ABS
Polycarbonato + ABS
Polycarbonato + ABS

DIF

Polycarbonato
Polycarbonato
Polycarbonato



Code	Color	Power	
PX-0135-NEG	● Black	Max. 8W (LED)	20



Post

- MAT** Aluminio
Aluminium
Aluminium
- DIF** Cristal
Glass
Verre

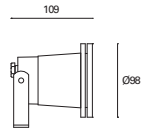

- GU10
- V/Hz
100-240V
50-60Hz
- CLASS I
- ✓
- 180°
- 180°
- IP 65
- IK 09
- INCLUDED

Code	Color	Power	
PX-1400-BLA	○ White	Max. 8W (LED)	20
PX-1400-GRI	● Grey	Max. 8W (LED)	20
PX-1400-NEG	● Black	Max. 8W (LED)	20



Neo

MAT Polycarbonato + ABS
 Polycarbonato + ABS
 Polycarbonato + ABS

DIF Polycarbonato
 Polycarbonato
 Polycarbonato

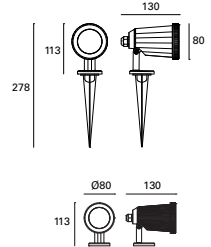

SEASIDE SUITABLE	LED	36.000 HOURS	VHZ 100-240V 50-60Hz
LED	DRIVER	INCLUDED	CRI ≥80
40°	CLASS I	90°	IP 65

Code	Color	Power	Kelvin	Rated flux	
PX-0374-NEG	● Black	6W	3000K	500 lm	16

Tidian

MAT Tecnopolimero
 Technopolymer
 Technopolymère

DIF Cristal
 Glass
 Verre

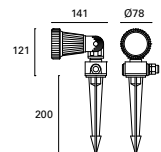

SEASIDE SUITABLE	GU10	VHZ 100-240V 50-60Hz	CLASS II
√	90°	IP 65	IK 07
0.2 M	INCLUDED		

Code	Color	Power	
PX-0214-NEG	● Black	Max. 8W (LED)	20



Minimal Green

MAT Aluminio
Aluminium
Aluminium

DIF Cristal
Glass
Verre

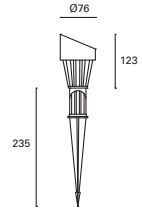
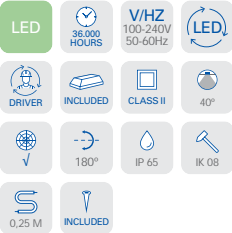

Code	Color	Power	Kelvin	Rated flux	
PX-0111-NEG	● Black	7,4W	Green	420 lm	20

Minimal

MAT Aluminio + Acero
Aluminium + Steel
Aluminium + Acier

DIF Cristal
Glass
Verre

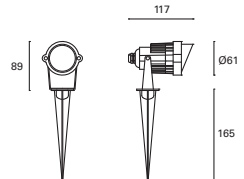
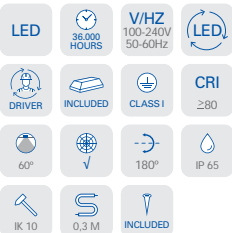

Code	Color	Power	Kelvin	Rated flux	
PX-0144-NEG	● Black	8W	3000K	715 lm	12
PX-0361-NEG	● Black	8,6W	4000K	780 lm	12



Lis NEW

MAT

PC y Acero inoxidable
 PC and Stainless steel
 PC et Acier inoxydable

DIF

Polycarbonato
 Polycarbonate
 Polycarbonate

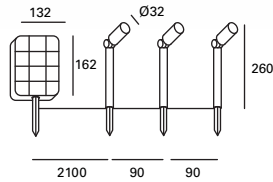

+INFO



-  SOLAR
-  TWILIGHT SENSOR
-  MAX. BH
2200 mAh
-  LED
-  36,000 HOURS
-  CLASS III
-  CRI
≥80
-  V
-  IP-44

Code	Color	Power	K	lm	⊞
PX-0451-NEG	● Black	3W	3000K	300 lm	4



Pro

MAT Aluminio
 Aluminium
 Aluminium

DIF Cristal
 Glass
 Verre

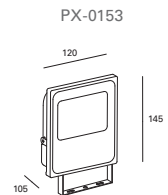
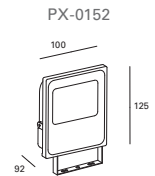

LED	36,000 HOURS	V/HZ 220-240V 50-60Hz	INCLUDED
CRI ≥80	90°	√	45°/90°
IP 66	IK 04	0,9 M	

	Code	Size	Color	Power	Kelvin	Rated flux	⊞
S	PX-0152-ANT	H125xL100mm	● Urban grey	10,2W	4000K	1400 lm	20
S	PX-0153-ANT	H145xL120mm	● Urban grey	31,1W	4000K	3800 lm	20



Way NEW

MAT

Aluminio
Aluminium
Aluminium

DIF

Polycarbonato
Polycarbonate
Polycarbonate



+INFO PX-0423



Apto para tránsito de personas.

Suitable for foot traffic.

Adapté au passage des personnes.

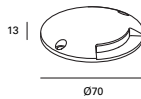

PX-0423



PX-0349



	Code	Color	Power	Kelvin	Rated flux	
N	PX-0423-GRI	● Grey	0,3W	3000K	27 lm	30
S	PX-0349-GRI	● Grey	0,4W	3000K	27 lm	30



Senya

- MAT** Aluminio Aluminium Aluminium
- DIF** Policarbonato Polycarbonate Polycarbonate

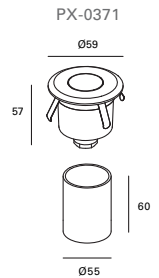
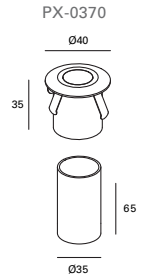

Apto para tránsito de personas.
Suitable for foot traffic.
Adapté au passage des personnes.

LED	36,000 HOURS	V/HZ 220-240V 50-60Hz	INCLUDED
CLASS II	CRI ≥80	60°	✓
IP 65/67	IK 10	0,3 M	INCLUDED

Code	Size	Color	Power	Kelvin	Rated flux	
PX-0370-ALU	D40xH35mm	● Aluminium	1W	3000K	45 lm	40
PX-0371-ALU	D59xH57mm	● Aluminium	1,7W	3000K	90 lm	20



Sort

MAT Aluminio Aluminium Aluminium

DIF Policarbonato Polycarbonate Polycarbonate

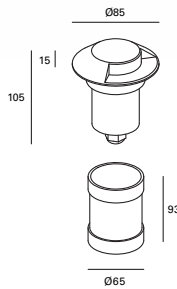

*
Apto para tránsito de personas.
Suitable for foot traffic.
Adapté au passage des personnes.

SEASIDE SUITABLE	LED	96,000 HOURS	VHZ 220-240V 50-60Hz
DRIVER	INCLUDED	CLASS I	CRI ≥80
IP 65	IK 10	0,3 M	
INCLUDED	36		

Code	Color	Power	Kelvin	Rated flux	
PX-0303-NEG	● Black	3,3W	3000K	225 lm	36



Icon

MAT

Aluminio / Policarbonato +ABS
Aluminium / Polycarbonate + ABS
Aluminium / Polycarbonate + ABS

DIF

Policarbonato
Polycarbonate
Polycarbonate

PX-0357

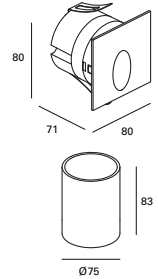

PX-0358

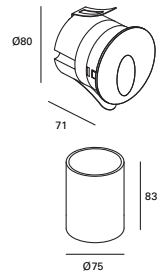

LED

36.000
HOURSV/HZ
220-240V
50-60Hz

INCLUDED

CLASS I

CRI
≥80

70°

V

IP 65

INCLUDED

Code	Size	Color	Power	Kelvin	Rated flux	
PX-0357-NEG	H80xL71mm	● Black	3,3W	3000K	228 lm	36
PX-0358-NEG	D80xL71mm	● Black	3,3W	3000K	228 lm	36



Rect NEW

MAT

Acero inoxidable AISI 304
 Stainless steel AISI 304
 Acier inoxydable AISI 304

DIF

Polycarbonato
 Polycarbonate
 Polycarbonate

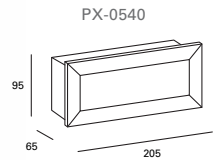
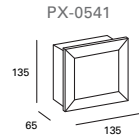

+INFO



PRO	LED	36.000 HOURS	VHZ 220-240V 50-60Hz
INCLUDED	CLASS I	CRI ≥80	IP 65
IK 07	0,1 M	INCLUDED	

Code	Size	Color	Power	Kelvin	Rated flux	
PX-0541-ALU	L135xH135mm	● Grey	3,3W	3000K	345 lm	48
PX-0540-ALU	L205xH95mm	● Grey	3,3W	3000K	345 lm	48



PRO	LED	36,000 HOURS	V/HZ 220-240V 50-60Hz
CCT	INCLUDED	CLASS II	CRI ≥80
IP 65	IK 07	0,1 M	INCLUDED

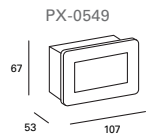

Code	Color	Power	Kelvin	Rated flux	
PX-0549-ALU	● Grey	2,3W	3000K, 4000K, 6500K	323 lm*	100

* Valor basado en 4000K. Value based on 4000K. Valeur basée sur 4000K.

Stair

MAT Acero inoxidable AISI 304
Stainless steel AISI 304
Acier inoxydable AISI 304

DIF Policarbonato
Polycarbonate
Polycarbonate

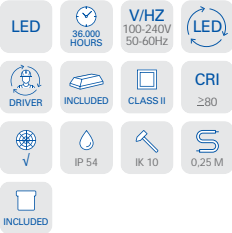
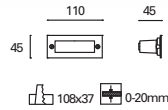

Code	Color	Power	Kelvin	Rated flux	
PX-0122-INO	● Stainless steel	1,3W	3000K	150 lm	40

Face

MAT Aluminio
Aluminium
Aluminium

DIF Cristal
Glass
Verre

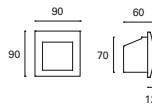

Code	Color	Power	Kelvin	Rated flux	
PX-0284-GRI	● Grey	3,3W	3000K	340 lm	50
PX-0285-GRI	● Grey	3,3W	4000K	370 lm	50



Tamesis

MAT Aluminio Aluminium Aluminium

DIF Cristal Glass Verre



3 tapas incluidas
3 covers included
3 couvertures inclus

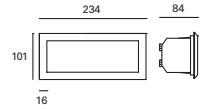

Code	Color	Power	
PX-0047-GRI	● ○ ● Black + White + Grey	Max.15W (LED)	18

MAT Acero inoxidable AISI 304 Stainless steel AISI 304 Acier inoxydable AISI 304

DIF Cristal Glass Verre



Tapa incluida
Cover included
Couverture inclus

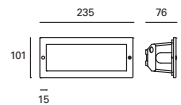

Code	Color	Power	
PX-0465-INO	● Stainless steel	Max.15W (LED)	18



Hide NEW

MAT Aluminio
 Aluminium
 Aluminium

DIF Policarbonat
 Polycarbonate
 Polycarbonate

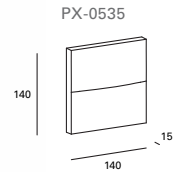
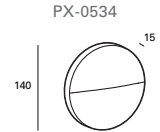

+INFO PX-0534 / PX-0535



PRO SEASIDE SUITABLE LED 36.000 HOURS

V/HZ 220-240V 50-60Hz INCLUDED SERIAL INSTALLATION CLASS II

CRI ≥80 IP 65

Code	Size	Color	Power	Kelvin	Rated flux	ⓘ
PX-0534-ANT	D140xL15mm	● Urban grey	2,7W	4000K	268 lm	24
PX-0535-ANT	H140xL15mm	● Urban grey	2,7W	4000K	268 lm*	24



+INFO PX-0536



PRO	SEASIDE SUITABLE	LED	36.000 HOURS
V/HZ 220-240V 50-60Hz	INCLUDED	SERIAL INSTALLATION	CLASS I
CRI ≥80	IP 65		

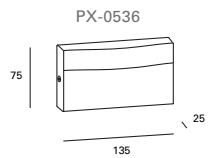

Code	Color	Power	Kelvin	Rated flux	
PX-0536-ANT	● Urban grey	8,2W	4000K	812 lm	16

Nod

MAT Aluminio
 Aluminium
 Aluminium

DIF Policarbonat
 Polycarbonate
 Polycarbonate

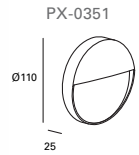
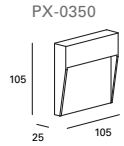

LED	36,000 HOURS	V/HZ 220-240V 50-60Hz	INCLUDED
CRI ≥80	CLASS I	IP 65	✓

Code	Size	Color	Power	Kelvin	Rated flux	
PX-0350-NEG	H105xL25mm	● Black	2,6W	3000K	210 lm	40
PX-0350-BLA	H105xL25mm	○ White	2,6W	3000K	210 lm	40
PX-0351-NEG	D110xL25mm	● Black	2,6W	3000K	210 lm	40
PX-0351-BLA	D110xL25mm	○ White	2,6W	3000K	210 lm	40



Grove

MAT ABS
 ABS
 ABS

DIF Policarbonato
 Polycarbonate
 Polycarbonate

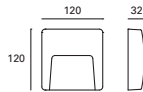

3 tapas incluidas
 3 covers included
 3 couvertures inclus

SEASIDE SUITABLE	LED	36.000 HOURS	VHZ 100-240V 50-60Hz
LED	INCLUDED	SERIAL INSTALLATION	CLASS II
CRI ≥80	IP 65	IK 10	

Code	Color	Power	Kelvin	Rated flux	
PX-0439-NEG	● ○ ● Black + White + Grey	3,1W	4000K	300 lm	20



Grove

MAT Polycarbonato + ABS
Polycarbonate + ABS
Polycarbonate + ABS

DIF Polycarbonato
Polycarbonate
Polycarbonate



PX-0126

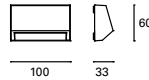

3 tapas incluidas
3 covers included
3 couvertures inclus

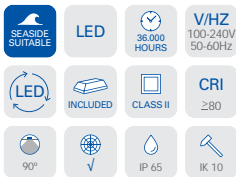

PX-0130

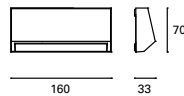

PX-0130



Code	Color	Power	Kelvin	Rated flux	
PX-0126-NEG	● ○ ● Black + White + Grey	1,6W	4000K	200 lm	40
PX-0130-NEG	● ○ ● Black + White + Grey	2,9W	4000K	350 lm	20



Incluye filtro para recrear luz cálida 3000°K.
It includes filter to recreate warm light 3000°K.
Comprend filtre à recréer une lumière chaude 3000°K.

Grove

MAT Polycarbonato + ABS
Polycarbonato + ABS
Polycarbonato + ABS

DIF Polycarbonato
Polycarbonato
Polycarbonato



3 tapas incluidas
3 covers included
3 couvertures inclus

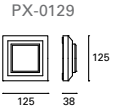

Code	Color	Power	Kelvin	Rated flux	
PX-0129-NEG	● ○ ● Black + White + Grey	2,5W	4000K	400 lm	20



3 tapas incluidas
3 covers included
3 couvertures inclus

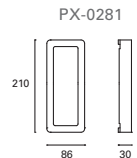

Code	Color	Power	Kelvin	Rated flux	
PX-0281-NEG	● ○ ● Black + White + Grey	3,4W	4000K	400 lm	18

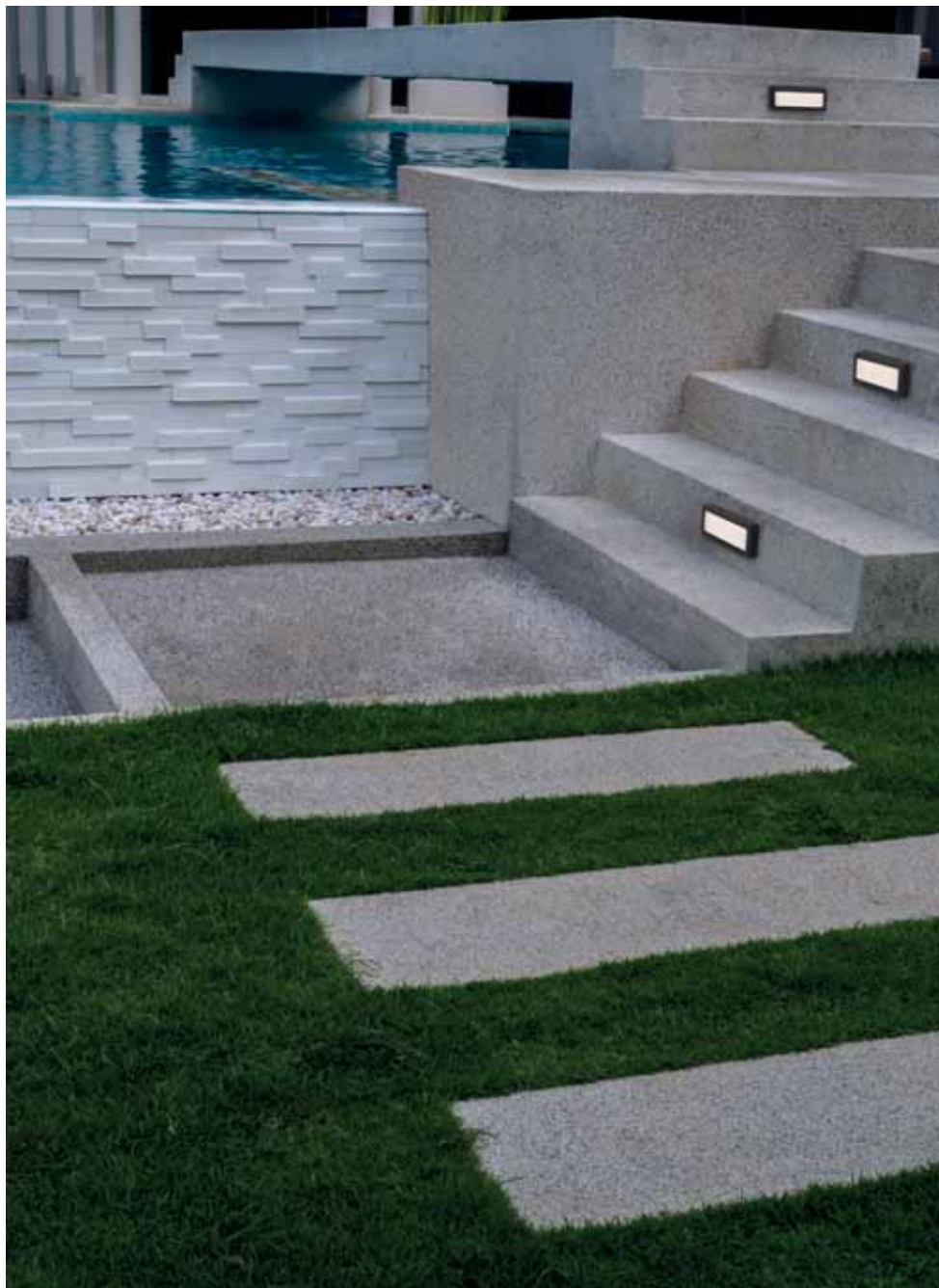

Mocca

MAT Aluminio
 Aluminium
 Aluminium

DIF Policarbonato
 Polycarbonate
 Polycarbonate

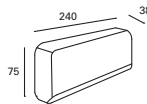

LED	36.000 HOURS	V/HZ 220-240V 50-60Hz	(LED)
DRIVER	INCLUDED	SERIAL INSTALLATION	CLASS II
CRI ≥80	IP 65	IK 08	

	Code	Color	Power	Kelvin	Rated flux	
S	PX-0493-GRI	● Grey	4,7W	3000K	490 lm	24
S	PX-0493-NEG	● Black	4,7W	3000K	490 lm	24



Moo NEW

- MAT** PMMA
PMMA
PMMA
- DIF** Plástico
Plastic
Plastique

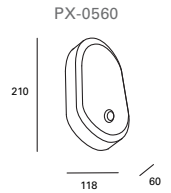
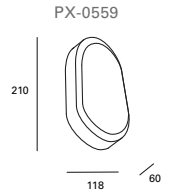

+INFO PX-0559



+INFO PX-0560



- PRO**
- CCT**
- LED**
- 36.000 HOURS
- V/HZ** 220-240V 50-60Hz
- CLASS II**
- CRI** ≥80
- ✓
- IP 54
- IK 09

PX-0560



Code	Size	Color	Power	Kelvin	Rated flux	
PX-0559-BLA	H210xL118mm	○ White	17W	3000K, 4000K, 6000K	2130 lm*	24
PX-0560-BLA	H210xL118mm	○ White	17W	3000K, 4000K, 6000K	2130 lm*	24

* Valor basado en 4000K. Value based on 4000K. Valeur basée sur 4000K.



New flash

MAT Policarbonato
 Polycarbonate
 Polycarbonate

DIF Policarbonato
 Polycarbonate
 Polycarbonate

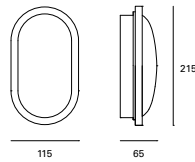

LED	36,000 HOURS	V/HZ 100-240V 50-60Hz	(LED)
DRIVER	INCLUDED	CLASS II	CRI ≥80
IP 44	IK 10	0,1 M	

Code	Color	Power	Kelvin	Rated flux	
PX-0507-BLA	○ White	15,8W	3000K	1500 lm	6
PX-0507-NEG	● Black	15,8W	3000K	1500 lm	6





Area

MAT Polycarbonato + ABS
 Polycarbonate + ABS
 Polycarbonate + ABS

DIF Polycarbonato
 Polycarbonate
 Polycarbonate

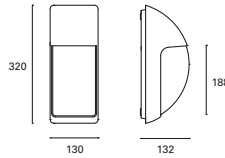

Code	Color	Power	
PX-0352-BLA	○ White	Max. 15W (LED)	9
PX-0352-GRI	● Grey	Max. 15W (LED)	9
PX-0352-NEG	● Black	Max. 15W (LED)	9



Block NEW

MAT

Aluminio
Aluminium
Aluminium

DIF

Polycarbonato
Polycarbonate
Polycarbonate

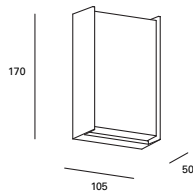

+INFO

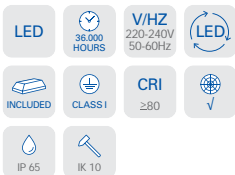

Code	Color	Power	Kelvin	Rated flux	
PX-0454-ANT	● Anthracite	9,7W	4000K	1125 lm	8



Thomas

MAT

Aluminio + Polipropileno
Aluminium + Polypropylene
Aluminium + Polypropylène

DIF

Policarbonato
Polycarbonate
Polycarbonate

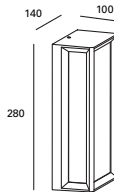

Code	Color	Power	
PX-0148-ANT	● Urban grey	Max. 15W (LED)	8



Opalo

MAT

Aluminio
Aluminium
Aluminium

DIF

Policarbonato
Polycarbonate
Polycarbonate

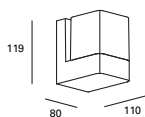

Code	Color	Power	Kelvin	Rated flux	
PX-0372-NEG	● Black	9,4W	3000K	975 lm	8



Monaco

MAT

Aluminio
 Aluminium
 Aluminium

DIF

Polycarbonato
 Polycarbonate
 Polycarbonate

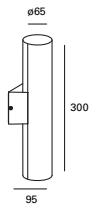

LED	36.000 HOURS	V/HZ 100-240V 50-60Hz	(LED)
DRIVER	INCLUDED	SERIAL INSTALLATION	CLASS 1
CRI ≥80	√	IP 54	IK 06

	Code	Color	Power	Kelvin	Rated flux	
S	PX-0149-GRI	● Grey	6,2W	3000K	620 lm	6



Bow

MAT

Aluminio
Aluminium
Aluminium

DIF

Policarbonato
Polycarbonate
Polycarbonate

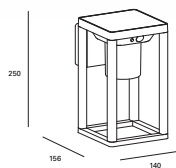

+INFO PX-0174

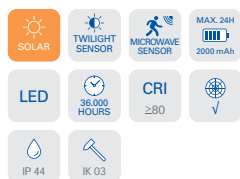

Code	Color	Power	Kelvin	Rated flux	
PX-0174-ANT	● Urban grey	3W	3000K	400 lm	12



Nika

MAT

Acero
Steel
Acier

DIF

Cristal
Glass
Verre

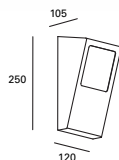

Code	Color	Power	
PX-0203-NEG	● Black	Max. 15W (LED)	10



Kala

MAT

Aluminio
Aluminium
Aluminium

DIF

Cristal
Glass
Verre

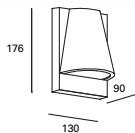

Code	Color	Power	
PX-0383-ANT	● Urban grey	Max. 8W (LED)	12



Serenate

- MAT** Aluminio
Aluminium
Aluminium
- DIF** Policarbonato
Polycarbonate
Polycarbonate

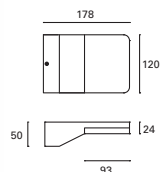

LED	36,000 HOURS	V/HZ 100-240V 50-60HZ	DRIVER
INCLUDED	CLASS I	CRI ≥80	✓
IP 44	IK 10		

Code	Color	Power	Kelvin	Rated flux	☒
PX-0254-NEG	● Black	8,5W	3000K	1000 lm	10

Samper

- MAT** Policarbonato + ABS
Polycarbonate + ABS
Polycarbonate + ABS
- DIF** Policarbonato
Polycarbonate
Polycarbonate

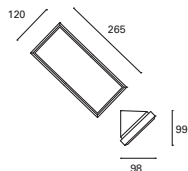

SEASIDE SUITABLE	LED	36,000 HOURS	V/HZ 100-240V 50-60HZ
LED	DRIVER	INCLUDED	CLASS II
CRI ≥80	✓	IP 65	IK 08

Code	Color	Power	Kelvin	Rated flux	☒
PX-0353-GRI	○ Grey	12W	3000K	1100 lm	16
PX-0353-NEG	● Black	12W	3000K	1100 lm	16



Mayor

MAT

Aluminio
Aluminium
Aluminium

DIF

Cristal
Glass
Verre

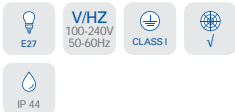
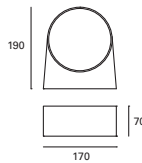

	Code	Color	Power	
S	PX-0005-GRI	● Grey	Max. 15W (LED)	12
	PX-0005-ANT	● Anthracite	Max. 15W (LED)	12



Top

- MAT** Aluminio
Aluminium
Aluminium
- DIF** Vidrio templado
Tempered glass
Verre trempé

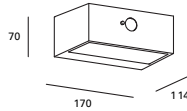

+INFO PX-0171



- SOLAR
- TWILIGHT SENSOR
- MICROWAVE SENSOR
- MAX. 24H
2000 mAh
- 36,000 HOURS
- LED
- CRI
≥80
- \checkmark
- IP-44
- IK-03

Code	Color	Power	Kelvin	Rated flux	
PX-0171-ANT	● Urban grey	3W	3000K	400 lm	16



Tilt NEW

MAT Aluminio
Aluminium
Aluminium

DIF Policarbonato
Polycarbonate
Polycarbonate

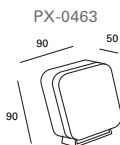

+INFO

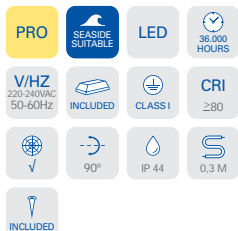

Code	Color	Power	Kelvin	Rated flux	
N PX-0463-ANT	● Black	6,6W	4000K	600 lm	12

MAT Aluminio
Aluminium
Aluminium

DIF Policarbonato
Polycarbonate
Polycarbonate

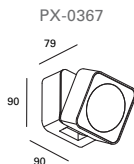

+INFO

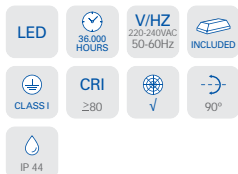

Code	Color	Power	Kelvin	Rated flux	
PX-0367-ANT	○ White	7W	3000K	750 lm	12



PX-0463



Otra posibilidad.
Another possibility.
Autre possibilité.

Pixa NEW

MAT

Acero inoxidable AISI 202
 Stainless steel AISI 202
 Acier inoxydable AISI 202

DIF

Cristal
 Glass
 Verre

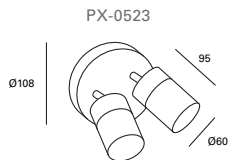
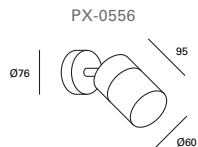

+INFO PX-0556



+INFO PX-0523



Code	Size	Color	Power	
PX-0556-NEG	D76xL95mm	● Black	Max. 8W (LED)	12
PX-0523-NEG	D108xL95mm	● Black	2x Max. 8W (LED)	12



Eleve

MAT Aluminio
Aluminium
Aluminium

DIF Cristal
Glass
Verre

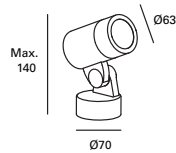

Producto 3 in 1, apto para instalación en pared, techo y suelo.

3 in 1 product, suitable for wall, ceiling and floor installation.

Produit 3 en 1, convenant à une installation au mur, au plafond et au sol.



Code	Color	Power	
PX-0366-NEG	● Black	Max. 8W (LED)	20



Cone NEW

MAT

ABS
ABS
ABS

DIF

Polycarbonato
Polycarbonate
Polycarbonate

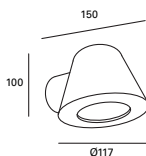

+INFO



Code	Color	Power	
PX-0499-NEG	● Black	Max. 8W (LED)	20



Prisma NEW

MAT

Polycarbonato + ABS
 Polycarbonate + ABS
 Polycarbonate + ABS

DIF

Polycarbonato
 Polycarbonate
 Polycarbonate



PX-0545

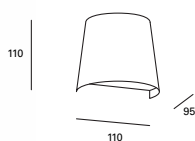

PX-0551

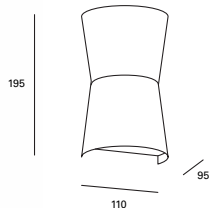

+INFO PX-0545



+INFO PX-0551



Code	Size	Color	Power	
PX-0545-NEG	H110xL105mm	● Black	Max. 8W (LED)	20
PX-0551-NEG	H195xL105mm	● Black	2x Max. 8W (LED)	24



Foix NEW

MAT ABS
ABS
ABS

DIF Policarbonato
Polycarbonate
Polycarbonate

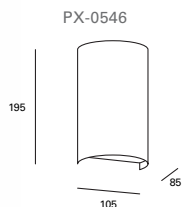
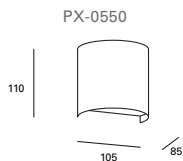

+INFO PX-0546



+INFO PX-0550



Code	Size	Color	Power	
PX-0546-NEG	H110xL105mm	● Black	Max. 8W (LED)	20
PX-0550-NEG	H195xL105mm	● Black	2x Max. 8W (LED)	24



Kubo

MAT Polycarbonato + ABS
 Polycarbonato + ABS
 Polycarbonato + ABS

DIF Polycarbonato
 Polycarbonato
 Polycarbonato

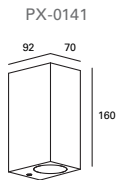
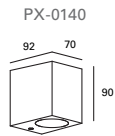

Code	Size	Color	Power	
PX-0140-NEG	H90xL70mm	● Black	Max. 8W (LED)	20
PX-0141-NEG	H160xL70mm	● Black	2x Max. 8W (LED)	20



Cube

- MAT** Acero
Steel
Acier
- DIF** Cristal
Glass
Verre

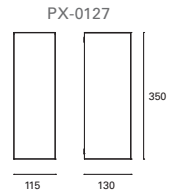
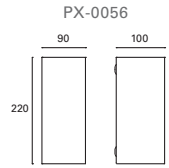

- V/HZ 100-240V
50-60Hz
- CLASS I
- √
- IP 44

PX-0056

- GU10
- IK 03

PX-0127

- E27
- IK 04

Code	Size	Color	Power	
PX-0056-GRI	H220xL90mm	● Grey	2x Max. 8W (LED)	12
PX-0056-NEG	H220xL90mm	● Black	2x Max. 8W (LED)	12
PX-0127-NEG	H350xL115mm	● Black	2x Max. 15W (LED)	8



Ara

MAT

Polycarbonato + ABS
Polycarbonate + ABS
Polycarbonate + ABS

DIF

Polycarbonato
Polycarbonate
Polycarbonate



PX-0376

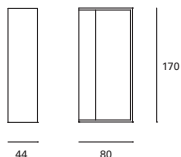

LED



V/HZ
100-240V
50-60Hz



CRI

≥200



IP 65



IK 06

Code	Color	Power	Kelvin	Rated flux	⊞
PX-0376-ANT	● Urban grey	9,3W	3000K	820 lm	40
PX-0376-BLA	○ White	9,3W	3000K	820 lm	40



PX-0375

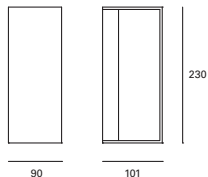

V/HZ
100-240V
50-60Hz



IP 65



IK 06

Code	Color	Power	⊞
PX-0375-ANT	● Urban grey	Max.15W (LED)	16
PX-0375-BLA	○ White	Max.15W (LED)	16



Loyd

MAT Aluminio
 Aluminium
 Aluminium

DIF Cristal
 Glass
 Verre

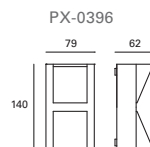

LED	36,000 HOURS	V/HZ 100-240V 50-60Hz	LED
DRIVER	INCLUDED	CLASS I	CRI ≥80
IP 54			

	Code	Size	Color	Power	Kelvin	Rated flux	
S	PX-0395-GRI	H75xL79mm	● Grey	3,4W	3000K	180 lm	20
	PX-0395-NEG	H75xL79mm	● Black	3,4W	3000K	180 lm	20
S	PX-0396-GRI	H140xL79mm	● Grey	5,9W	3000K	360 lm	20
	PX-0396-NEG	H140xL79mm	● Black	5,9W	3000K	360 lm	20



Orion

MAT Aluminio
 Aluminium
 Aluminium

DIF Cristal
 Glass
 Verre

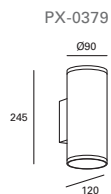
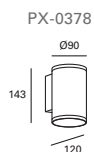

LED	36,000 HOURS	V/HZ 100-240V 50-60Hz	LED
DRIVER	INCLUDED	CLASS I	CRI ≥80
20°	✓	IP 54	IK 07

Code	Size	Color	Power	Kelvin	Rated flux	⊞
PX-0378-GRI	H143xD90mm	● Grey	7,3W	3000K	610 lm	10
PX-0378-NEG	H143xD90mm	● Black	7,3W	3000K	610 lm	10
PX-0379-GRI	H245xD90mm	● Grey	13,1W	3000K	1220 lm	10
PX-0379-NEG	H245xD90mm	● Black	13,1W	3000K	1220 lm	10



Slim NEW

MAT Aluminio
Aluminium
Aluminium

DIF Cristal
Glass
Verre

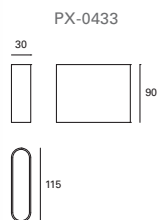

+INFO PX-0563



- LED
- 36,000 HOURS
- DRIVER
- INCLUDED
- CLASS I
- CRI ≥80
- IP 54

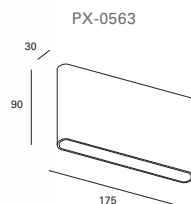

PX-0433

V/HZ
100-240V
50-60Hz

PX-0563

V/HZ
220-240V
50-60Hz

Code	Size	Color	Power	Kelvin	Rated flux	
PX-0433-BLA	L115xH90mm	○ White	5W	3000K	320 lm	20
PX-0433-ANT	L115xH90mm	● Urban grey	5W	3000K	320 lm	20
PX-0563-NEG	L175xH90mm	● Black	10,3W	3000K	1200 lm	20



Wilow

MAT Aluminio
 Aluminium
 Aluminium

DIF Cristal
 Glass
 Verre

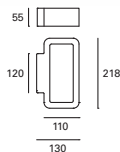

- LED**
- 36,000 HOURS**
- V/HZ**
100-240V
50-60Hz
- DRIVER**
- INCLUDED**
- CLASS I**
- CRI**
≥80
- IP 54**
- IK 10**

	Code	Color	Power	Kelvin	Rated flux	Ⓜ
S	PX-0397-GRI	● Grey	8,8W	3000K	600 lm	20
	PX-0397-NEG	● Black	8,8W	3000K	600 lm	20



Courbe

MAT

Aluminio
Aluminium
Aluminium

DIF

Policarbonato
Polycarbonate
Polycarbonate

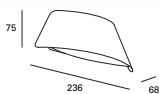

Code	Color	Power	Kelvin	Rated flux	
PX-0373-ANT	● Urban grey	8,5W	3000K	960 lm	9



Kapa

MAT

Aluminio
Aluminium
Aluminium

DIF

Polycarbonato
Polycarbonate
Polycarbonate



Módulo LED fácilmente reemplazable.

Easily replaceable LED module.

Module LED facilement remplaçable.

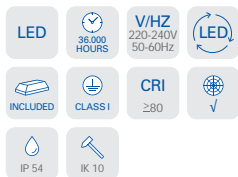
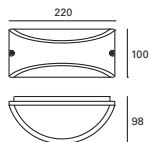

Code	Color	Power	Kelvin	Rated flux	
PX-0468-BLA	○ White	10W	3000K	945 lm	12
PX-0468-ANT	● Urban grey	10W	3000K	945 lm	12
PX-0525-BLA	○ White	10W	4000K	945 lm	12
PX-0525-ANT	● Urban grey	10W	4000K	945 lm	12



Shape

MAT Aluminio
 Aluminium
 Aluminium

DIF Cristal
 Glass
 Verre



Apto para instalar en posición vertical y horizontal.

Suitable for vertical and horizontal installation.

Convient pour une installation verticale et horizontale.

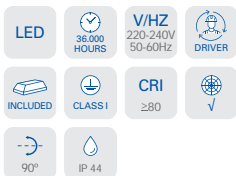
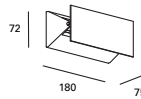

Code	Color	Power	Kelvin	Rated flux	
PX-0359-BLA	○ White	6,3W	3000K	648 lm	24
PX-0359-NEG	● Black	6,3W	3000K	648 lm	24

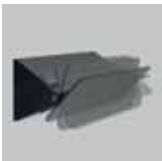

Iluminación up/down con haz de luz ajustable.
Up / down illumination with adjustable beam.
Éclairage haut/bas avec faisceau réglable.

Rex

MAT Aluminio
 Aluminium
 Aluminium

DIF Cristal
 Glass
 Verre

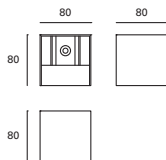

LED
 36,000 HOURS
V/HZ
 100-240V
 50-60Hz
DRIVER

INCLUDED
CLASS I
CRI
 ≥80
✓

IP 54
IK 08

Code	Color	Power	Kelvin	Rated flux	
PX-0432-BLA	○ White	6,6W	3000K	680 lm	27
PX-0432-ANT	● Urban grey	6,6W	3000K	680 lm	27
PX-0526-BLA	○ White	6,6W	4000K	760 lm	27
PX-0526-ANT	● Urban grey	6,6W	4000K	760 lm	27



Efecto de la luz fácilmente ajustable.
Easily adjustable light effect.
Effet de lumière facilement ajustable.

Brit NEW

MAT Aluminio
 Aluminium
 Aluminium

DIF Policarbonato
 Polycarbonate
 Polycarbonate

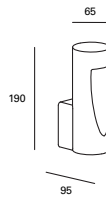

+INFO



PRO	SEASIDE SUITABLE	LED	36.000 HOURS
V/HZ 220-240VAC 50-60Hz	INCLUDED	CLASS I	CRI ≥80
✓	IP 54	IK 10	

Code	Color	Power	Kelvin	Rated flux	⊞
PX-0544-ANT	● Urban grey	7,1W	3000K	855 lm	9



Yika

MAT Polycarbonato + ABS
 Polycarbonate + ABS
 Polycarbonate + ABS

DIF Polycarbonato
 Polycarbonate
 Polycarbonate

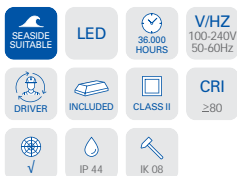
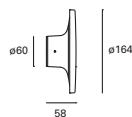

Code	Color	Power	Kelvin	Rated flux	⊞
PX-0486-NEG	● Black	7,9W	3000K	690 lm	12

Indoo

MAT Polycarbonato
 Polycarbonate
 Polycarbonat

DIF Polycarbonato
 Polycarbonate
 Polycarbonate

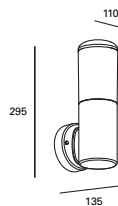

Code	Color	Power	⊞
S PX-0133-NEG	● Black	Max. 15W (LED)	12



Corande

MAT

Polycarbonato + ABS
Polycarbonato + ABS
Polycarbonato + ABS

DIF

Polycarbonato
Polycarbonato
Polycarbonato

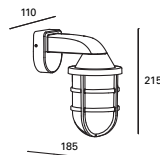

	Code	Color	Power	
S	PX-0147-NEG	● Black	Max. 15W (LED)	8

Elaine NEW

MAT

Aluminio
Aluminium
Aluminium

DIF

Polycarbonato
Polycarbonate
Polycarbonate

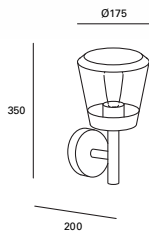

+INFO



Code

Color

Power



PX-0504-ANT

● Urban grey

Max. 15W (LED)

4



Lamtam NEW

MAT Aluminio + ABS
Aluminium + ABS
Aluminium + ABS

DIF Polipropileno
Polypropylene
Polypropylène

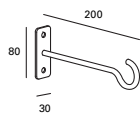

Soporte para pared incluido.
Wall mounting bracket included.
Support mural inclus.

+INFO

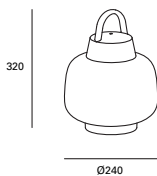

Code	Color	Power	
PX-0538-NEG	● Black	Max. 15W (LED)	8





Avenue

MAT Acero + Aluminio
 Steel + Aluminium
 Acier + Aluminium

DIF Cristal
 Glass
 Verre

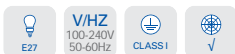
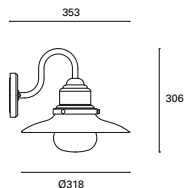

Code	Color	Power	⊞
PX-0252-NEG	● Black	Max. 15W (LED)	4



Osaka

MAT

Acero
Steel
Acier

DIF

Policarbonato
Polycarbonate
Polycarbonate

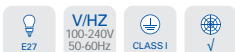
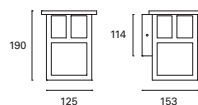

Code	Color	Power	⊞
PX-0028-OXI	● Rusty brown	Max. 15W (LED)	6

Adur

MAT

Aluminio
Aluminium
Aluminium

DIF

Cristal
Glass
Verre

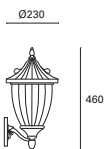

	Code	Color	Power	
S	PX-0240-OXI	● Rusty brown	Max. 15W (LED)	4



Elix

MAT Acero inoxidable AISI 202
 Stainless steel AISI 202
 Acier inoxydable AISI 202

DIF Cristal
 Glass
 Verre

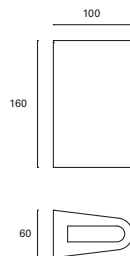

Code	Color	Power	Kelvin	Rated flux	⊞
S PX-0251-INO	● Stainless steel	7,8W	3000K	600 lm	8

Siluet

MAT Acero inoxidable AISI 304
 Stainless steel AISI 304
 Acier inoxydable AISI 304

DIF Policarbonato
 Polycarbonate
 Polycarbonate

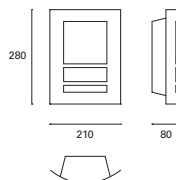

Code	Color	Power	⊞
PX-0246-INO	● Stainless steel	Max. 15W (LED)	6

Aifil

MAT Aluminio
Aluminium
Aluminium

DIF Cristal
Glass
Verre

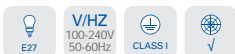
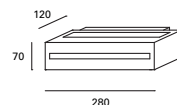

Code	Color	Power	
------	-------	-------	--

S PX-0034-ANT	● Urban grey	Max. 15W (LED)	6
---------------	--------------	----------------	---

Koral

MAT Acero inoxidable AISI 202
Stainless steel AISI 202
Acier inoxydable AISI 202

DIF Policarbonato
Polycarbonate
Polycarbonate

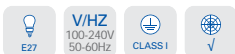
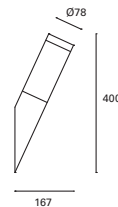

Code	Color	Power	
------	-------	-------	--

PX-0098-INO	● Stainless steel	Max. 15W (LED)	12
-------------	-------------------	----------------	----

Grow

MAT

Cemento
Cement
Ciment

DIF

Policarbonato
Polycarbonate
Polycarbonate

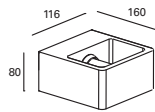

Acabado 100% cemento.

100% cement finish.

Finition 100 % ciment.



Code	Color	Power	
PX-0517-CEM	● Cement	Max. 6W (LED)	2



Box

MAT Cemento
 Cement
 Ciment

DIF Cristal
 Glass
 Verre

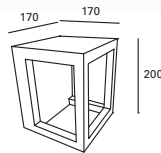

Acabado 100% cemento.

100% cement finish.

Finition 100 % ciment.

LED	36.000 HOURS	V/HZ 220-240V 50-60Hz	DRIVER
INCLUDED	CLASS II	CRI ≥80	✓
IP 65	IK 10		

Code	Color	Power	Kelvin	Rated flux	
S PX-0527-CEM	● Cement	4W	4000K	380 lm	2



Brit NEW

- MAT** Aluminio Aluminium Aluminium
- DIF** Policarbonato Polycarbonate Polycarbonate

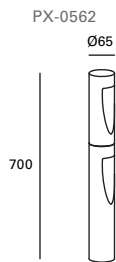
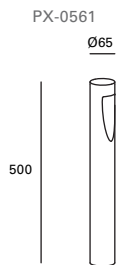

+INFO PX-0561



+INFO PX-0562



- PRO**
- SEASIDE SUITABLE
- LED
- 36.000 HOURS
- V/HZ 220-240VAC 50-60Hz
- INCLUDED
- CLASS I
- CRI ≥80
- IP 54
- IK 10

PX-0562



Code	Size	Color	Power	Kelvin	Rated flux	
PX-0561-ANT	H500xD65mm	● Urban grey	7,1W	3000K	855 lm	4
PX-0562-ANT	H700xD65mm	● Urban grey	14,2W	3000K	1710 lm	4



Hide NEW

MAT Aluminio Aluminium Aluminium

DIF Policarbonat Polycarbonate Polycarbonate

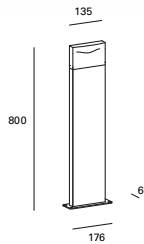

+INFO



PRO	SEASIDE SUITABLE	LED	36.000 HOURS
V/HZ 220-240V 50-60Hz	INCLUDED	CLASS I	CRI ≥80
✓	IP 65		

Code	Color	Power	Kelvin	Rated flux	⊞
PX-0537-ANT	● Urban grey	8,2W	4000K	812 lm	4



Cone NEW

MAT ABS
ABS
ABS

DIF Policarbonato
Polycarbonate
Polycarbonate

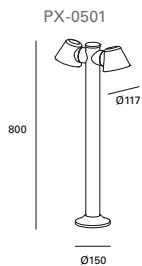
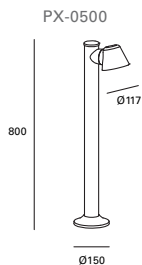

+INFO PX-0500



+INFO PX-0501



Code	Size	Color	Power	
PX-0500-NEG	H800xD150mm	● Black	Max. 8W (LED)	6
PX-0501-NEG	H800xD150mm	● Black	2x Max. 8W (LED)	4



Pixa NEW

MAT

Acero inoxidable AISI 202
Stainless steel AISI 202
Acier inoxydable AISI 202

DIF

Cristal
Glass
Verre



+INFO PX-0524



+INFO PX-0532

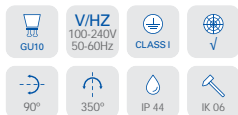
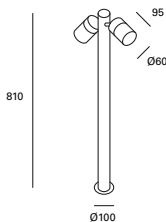

Code	Size	Color	Power	
PX-0524-NEG	H810xD100mm	● Black	2x Max. 8W (LED)	4



Lamtam NEW

- MAT** Aluminio + ABS
 Aluminium + ABS
 Aluminium + ABS
- DIF** Policarbonato
 Polycarbonate
 Polycarbonate

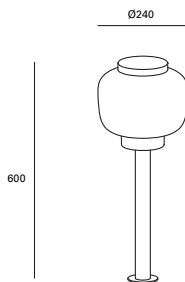

+INFO



Code	Color	Power	
PX-0539-NEG	● Black	Max. 15W (LED)	4



Elaine NEW

MAT

Aluminio
Aluminium
Aluminium

DIF

Polycarbonato
Polycarbonate
Polycarbonate



PX-0502

Ø175

600

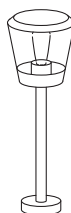

PX-0503

Ø175

1000



+INFO PX-0503



+INFO PX-0504



Code	Size	Color	Power	
PX-0502-ANT	H600xD175mm	● Urban grey	Max. 15W (LED)	4
PX-0503-ANT	H1000xD175mm	● Urban grey	Max. 15W (LED)	4



Kala

- MAT** Aluminio Aluminium Aluminium
- DIF** Cristal Glass Verre

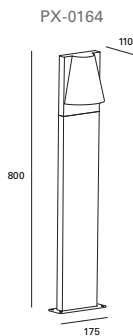
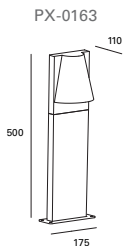

Excelente confort visual y nula contaminación lumínica.

Excellent visual comfort and zero light pollution.

Excellent confort visuel et aucune pollution lumineuse.

-
-
-
-
-

Code	Size	Color	Power	
PX-0102-ANT	H500xL110mm	● Urban grey	Max. 8W (LED)	4
PX-0103-ANT	H800xL110mm	● Urban grey	Max. 8W (LED)	4

Yika

- MAT** Policarbonato + ABS
Polycarbonate + ABS
Polycarbonate + ABS
- DIF** Policarbonato
Polycarbonate
Polycarbonate

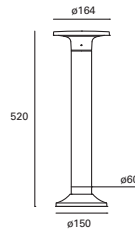

SEASIDE SUITABLE	LED	36.000 HOURS	VHZ 100-240V 50-60HZ
DRIVER	INCLUDED	CLASS II	CRI ≥90
IP 44	IK 08		

Code	Color	Power	Kelvin	Rated flux	
PX-0487-NEG	● Black	7,9W	3000K	690 lm	6

Bow

MAT

Aluminio
Aluminium
Aluminium

DIF

Polycarbonato
Polycarbonate
Polycarbonate

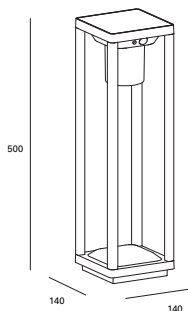

+INFO PX-0176



Code	Color	Power	Kelvin	Rated flux	
PX-0176-ANT	● Urban grey	3W	3000K	400 lm	6

Top

MAT

Aluminio
Aluminium
Aluminium

DIF

Vidrio templado
Tempered glass
Verre trempé

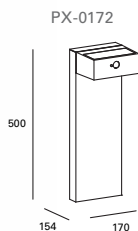

+INFO PX-0172



+INFO PX-0173

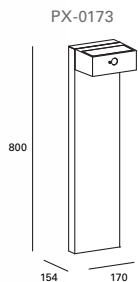

SOLAR	TWILIGHT SENSOR	MICROWAVE SENSOR	MAX. 24H 2000 mAh
36,000 HOURS	LED	CRI ≥90	✓
IP 44	IK 03		

Code	Size	Color	Power	Kelvin	Rated flux	
PX-0172-ANT	H500xL170mm	● Urban grey	3W	3000K	400 lm	4
PX-0173-ANT	H800xL170mm	● Urban grey	3W	3000K	400 lm	4

Koral

MAT

Acero inoxidable AISI 202
 AISI 202 Stainless steel
 Acier inoxydable AISI 202

DIF

Polycarbonato
 Polycarbonate
 Polycarbonate



PX-0099

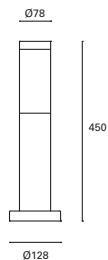

PX-0100

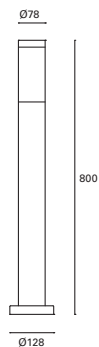

Code	Size	Color	Power	
PX-0099-ANT	H450xD78mm	● Urban grey	Max. 15W (LED)	4
PX-0099-INO	H450xD78mm	● Stainless steel	Max. 15W (LED)	4
PX-0100-ANT	H800xD78mm	● Urban grey	Max. 15W (LED)	4
PX-0100-INO	H800xD78mm	● Stainless steel	Max. 15W (LED)	4

Arrow

MAT

Aluminio
Aluminium
Aluminium

DIF

Polycarbonato
Polycarbonate
Polycarbonate

LED

36.000
HOURS

V/HZ
100-240V
50-60Hz

LED

DRIVER

INCLUDED

CLASS I

CRI
≥80

✓

IP 65

IK 09

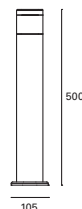

Code	Color	Power	Kelvin	Rated flux	⊞
PX-0139-NEG	● Black	6,6W	3000K	640 lm	9

Indoo

MAT

Polycarbonato
Polycarbonate
Polycarbonat

DIF

Polycarbonato
Polycarbonate
Polycarbonate

SEASIDE
SUITABLE

E27

V/HZ
100-240V
50-60Hz

CLASS II

✓

IP 44

IK 10

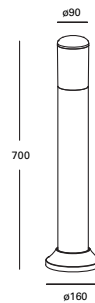

Code	Color	Power	⊞
PX-0134-NEG	● Black	Max. 15W (LED)	6

Mandela

MAT

Aluminio
Aluminium
Aluminium

DIF

Polycarbonato
Polycarbonate
Polycarbonate



PX-0086

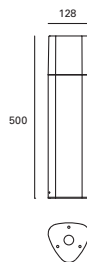

PX-0087

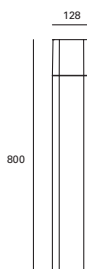

Code	Size	Color	Power	
PX-0086-ANT	H500xL128mm	● Urban grey	Max. 15W (LED)	6
PX-0087-ANT	H800xL128mm	● Urban grey	Max. 15W (LED)	6

Siljan

MAT

Acero inoxidable AISI 202
AISI 202 Stainless steel
Acier inoxydable AISI 202

DIF

Polycarbonato
Polycarbonate
Polycarbonate

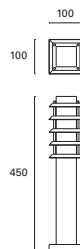

Code	Color	Power	
PX-0029-MAR	● Rusty brown	Max. 15W (LED)	12

Siros

MAT

Aluminio
Aluminium
Aluminium

DIF

Cristal
Glass
Verre



Code	Color	Power	
PX-0026-OXI	● Rusty brown	Max. 15W (LED)	6

Box

MAT Cemento
Cement
Ciment

DIF Cristal
Glass
Verre

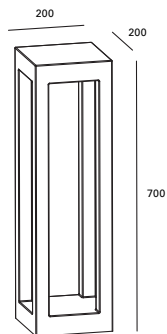
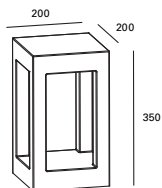

Acabado 100% cemento.

100% cement finish.

Finition 100 % ciment.



Code	Size	Color	Power	Kelvin	Rated flux	☒
PX-0161-CEM	H350xL200mm	● Cement	5,8W	4000K	580 lm	1
S PX-0162-CEM	H700xL200mm	● Cement	5,8W	4000K	580 lm	1

Afil

MAT

Aluminio
Aluminium
Aluminium

DIF

Cristal
Glass
Verre

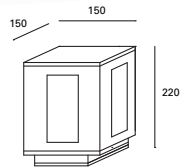

Code	Color	Power	
S PX-0033-ANT	● Urban grey	Max. 15W (LED)	4

Pixa NEW

MAT Acero inoxidable AISI 202
 Stainless steel AISI 202
 Acier inoxydable AISI 202

DIF Cristal
 Glass
 Verre

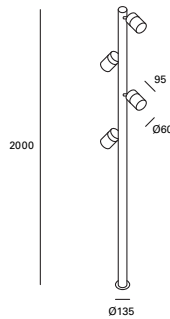

+INFO



GU10	V/Hz 100-240V 50-60Hz	CLASS I	V
90°	350°	IP 44	IK 06

Code	Size	Color	Power	
PX-0532-NEG	H2000xD135mm	● Black	4x Max. 8W (LED)	4

Siros

MAT

Aluminio inyectado
Injected aluminium
Aluminium injecté

DIF

Cristal
Glass
Verre

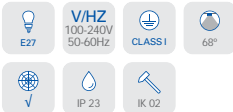
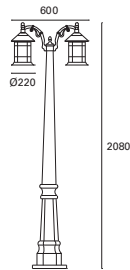

Code	Size	Color	Power	
PX-0027-OXI	H2080xL600mm	● Rusty brown	2x Max. 15W (LED)	1

Scal NEW

MAT Polipropileno
 Polypropylene
 Polypropylène

DIF Polipropileno
 Polypropylene
 Polypropylène



+INFO PX-0510 / PX-0512 / PX-518



+INFO PX-0513

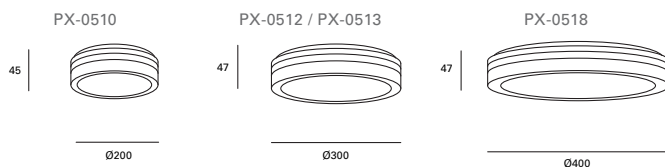

- PRO**
- CCT
- LED
- 36.000 HOURS
- V/HZ: 220-240V / 50-60Hz
- INCLUDED
- CLASS II
- CRI ≥80
- IP 54
- IK 10

PX-0513



Code	Size	Color	Power	Kelvin	Rated flux	lm*	20
PX-0510-BLA	D200xH45mm	○ White	14,4W	3000k, 4000k, 6000k	2160	lm*	20
PX-0512-BLA	D300xH47mm	○ White	23,1W	3000k, 4000k, 6000k	3360	lm*	10
PX-0513-BLA	D300xH47mm	○ White	23,1W	3000k, 4000k, 6000k	3360	lm*	10
PX-0518-BLA	D400xH47mm	○ White	32,6W	3000k, 4000k, 6000k	5100	lm*	10

* Valor basado en 4000K. Value based on 4000K. Valeur basée sur 4000K.



Ford

MAT Polycarbonato + ABS
 Polycarbonate + ABS
 Polycarbonate + ABS

DIF Polycarbonato
 Polycarbonate
 Polycarbonate

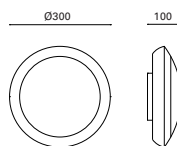

Code	Color	Power	⊞
PX-1801-BLA	○ White	2x Max. 15W (LED)	6
PX-1801-GRI	● Grey	2x Max. 15W (LED)	6

Orion

MAT Aluminio
 Aluminium
 Aluminium

DIF Cristal
 Glass
 Verre

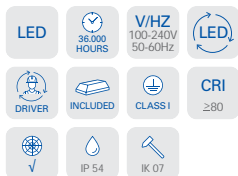
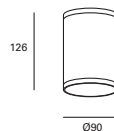

Code	Color	Power	Kelvin	Rated flux	⊞
PX-0380-GRI	● Grey	7,3W	3000K	610 lm	20
PX-0380-NEG	● Black	7,3W	3000K	610 lm	20



Rhino

MAT Policarbonato
 Polycarbonate
 Polycarbonate

DIF Policarbonato
 Polycarbonate
 Polycarbonate

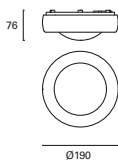

SEASIDE SUITABLE	LED	36.000 HOURS	VHZ 220-240V 50-60Hz
LED DRIVER	INCLUDED	CLASS II	
CRI ≥80	IP 65	IK 10	

Code	Color	Power	Kelvin	Rated flux	⊞
S PX-0096-ANT	● Urban grey	8W	4000K	900 lm	12



Selene

MAT

Aluminio
 Aluminium
 Aluminium

DIF

Cristal + PMMA
 Glass+ PMMA
 Verre+ PMMA

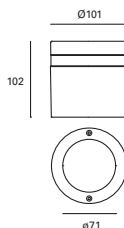

Incluye difusor en color azul.

Includes diffuser in blue

Comprend un diffuseur de couleur bleue.



Code Color Power

S PX-0464-GRI ● Grey Max. 8W (LED) 6



Port

MAT

Polycarbonato + ABS
Polycarbonate + ABS
Polycarbonate + ABS

DIF

Polycarbonato
Polycarbonate
Polycarbonate

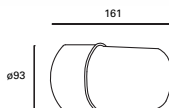

Posibilidad de usar como plafón de techo o como aplique de pared.

Can be used as a recessed ceiling light or wall light.

Possibilité de l'utiliser sous forme de plafonnier ou d'applique murale.



Code	Color	Power	
PX-0159-NEG	● Black	Max. 15W (LED)	18



Pop

- MAT** ABS
ABS
ABS
- DIF** Policarbonato
Polycarbonate
Polycarbonate



Instalación con conector rápido.
Installation with fast connector.
Installation avec connecteur rapide.

- PRO**
- LED**
- 36,000 HOURS
- V/HZ 220-240V 50-60Hz
- LED
- INCLUDED
- SERIAL INSTALLATION
- CLASS II
- CRI ≥80
- 120°
- IP 65
- IK 09

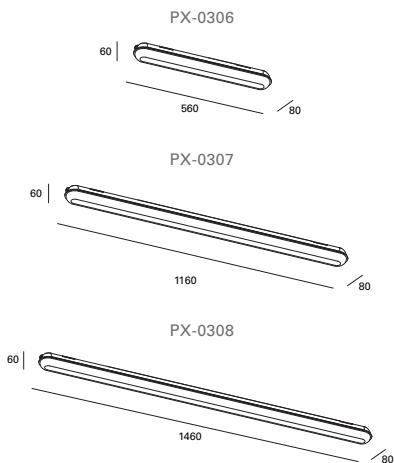

Code	Size	Color	Power	K	lm	
PX-0306-GRI	L560xH60mm	● Grey	16,7W	4000K	2588 lm	15
PX-0307-GRI	L1160xH60mm	● Grey	35,4W	4000K	4879 lm	12
PX-0308-GRI	L1460xH60mm	● Grey	44W	4000K	6426 lm	8



Brit NEW

MAT Aluminio Aluminium Aluminium

DIF Policarbonato Polycarbonate Polycarbonate

+INFO PX-0544



+INFO PX-0561



+INFO PX-0562



- PRO**
- SEASIDE SUITABLE
- LED
- 36.000 HOURS
- V/HZ 220-240VAC 50-60Hz
- INCLUDED
- CLASS I
- CRI ≥80
- IP 54
- IK 10

PX-0562

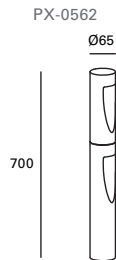
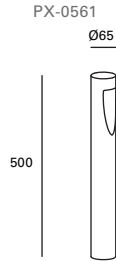
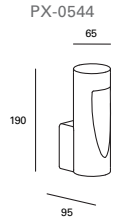

Code	Size	Color	Power	Kelvin	Rated flux	
PX-0544-ANT	H190xL95mm	● Urban grey	7,1W	3000K	855 lm	9
PX-0561-ANT	H500xD65mm	● Urban grey	7,1W	3000K	855 lm	4
PX-0562-ANT	H700xD65mm	● Urban grey	14,2W	3000K	1710 lm	4



Hide NEW

- MAT** Aluminio Aluminium Aluminium
- DIF** Policarbonat Polycarbonate Polycarbonate

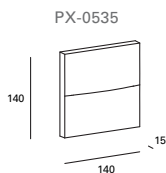
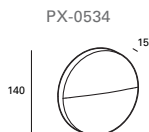
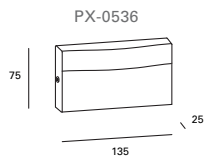

+INFO PX-0536



+INFO PX-0534 / PX-0535



- PRO**
- SEASIDE SUITABLE
- LED
- 36.000 HOURS
- V/HZ 220-240V 50-60Hz
- INCLUDED
- SERIAL INSTALLATION
- CRI ≥80
- IP 65

PX-0536



PX-0534 / PX-0535



Code	Size	Color	Power	Kelvin	Rated flux	
PX-0536-ANT	H75xL135mm	● Urban grey	8,2W	4000K	812 lm	16
PX-0534-ANT	D140xL15mm	● Urban grey	2,7W	4000K	268 lm	24
PX-0535-ANT	H140xL15mm	● Urban grey	2,7W	4000K	268 lm*	24



+INFO



PRO	SEASIDE SUITABLE	LED	36.000 HOURS
V/HZ 220-240V 50-60Hz	INCLUDED	CLASS I	CRI ≥80
	IP 65	4	

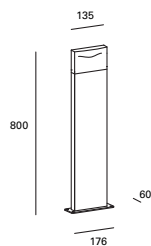

Code	Color	Power	Kelvin	Rated flux	
PX-0537-ANT	● Urban grey	8,2W	4000K	812 lm	4

Pixa NEW

MAT

Acero inoxidable AISI 202
Stainless steel AISI 202
Acier inoxydable AISI 202

DIF

Cristal
Glass
Verre

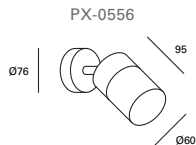
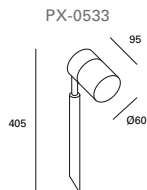

+INFO PX-0533



+INFO PX-0556



+INFO PX-0523

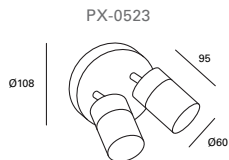

Code	Size	Color	Power	
PX-0533-NEG	H405xL95mm	● Black	Max. 8W (LED)	16
PX-0556-NEG	D76xL95mm	● Black	Max. 8W (LED)	12
PX-0523-NEG	D108xL95mm	● Black	2x Max. 8W (LED)	12

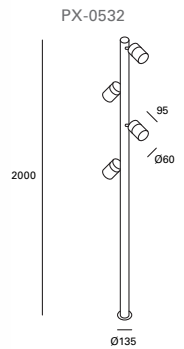
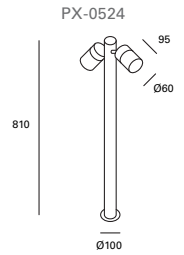

+INFO PX-0524



+INFO PX-0532



Code	Size	Color	Power	
PX-0524-NEG	H810xD100mm	● Black	2x Max. 8W (LED)	4
PX-0532-NEG	H2000xD135mm	● Black	4x Max. 8W (LED)	4

Elaine NEW

MAT

Aluminio
Aluminium
Aluminium

DIF

Polycarbonato
Polycarbonate
Polycarbonate

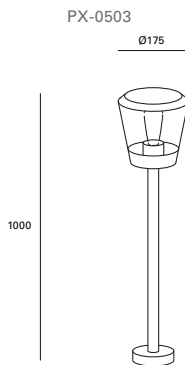
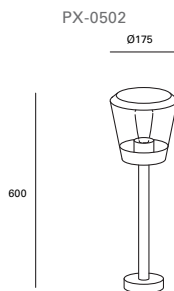
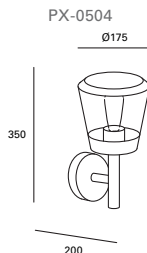

+INFO PX-0504



+INFO PX-0502 / PX-0503



Code	Size	Color	Power	
PX-0504-ANT	H350xD175mm	● Urban grey	Max. 15W (LED)	4
PX-0502-ANT	H600xD175mm	● Urban grey	Max. 15W (LED)	4
PX-0503-ANT	H1000xD175mm	● Urban grey	Max. 15W (LED)	4



Cone NEW

- MAT** ABS
ABS
ABS
- DIF** Policarbonato
Polycarbonate
Polycarbonate

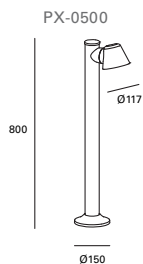
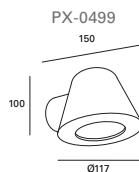

+INFO PX-0499



+INFO PX-0500



+INFO PX-0501

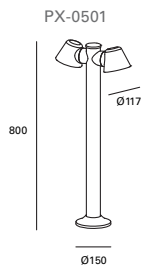

SEASIDE SUITABLE

GU10

V/HZ 100-240V 50-60HZ

CLASS II

IP 54

IK 09

PX-0499



PX-0500 / PX-0501



Code	Size	Color	Power	
PX-0499-NEG	H100xD150mm	● Black	Max. 8W (LED)	20
PX-0500-NEG	H800xD150mm	● Black	Max. 8W (LED)	6
PX-0501-NEG	H800xD150mm	● Black	2x Max. 8W (LED)	4



Lamtam NEW

MAT

Aluminio + ABS
Aluminium + ABS
Aluminium + ABS

DIF

Polycarbonato
Polycarbonate
Polycarbonate



PX-0538

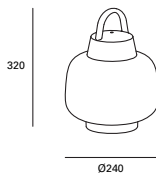

PX-0538

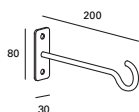

Soporte para pared incluido.
Wall mounting bracket included.
Support mural inclus.

+INFO PX-0538



+INFO PX-0539



PX-0538



PX-0539

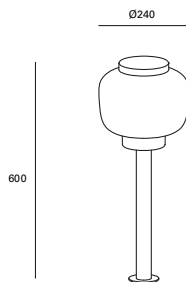

Code	Size	Color	Power	
PX-0538-NEG	H320xD240mm	● Black	Max. 15W (LED)	8
PX-0539-NEG	H600xD240mm	● Black	Max. 15W (LED)	4



Kala

MAT

Aluminio
Aluminium
Aluminium

DIF

Cristal
Glass
Verre



PX-0383

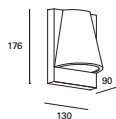

PX-0102

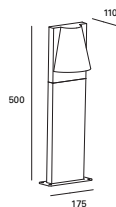

PX-0103

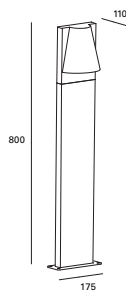

Code	Size	Color	Power	
PX-0383-ANT	H176xL130mm	● Urban grey	Max. 8W (LED)	12
PX-0102-ANT	H500xL110mm	● Urban grey	Max. 8W (LED)	4
PX-0103-ANT	H800xL110mm	● Urban grey	Max. 8W (LED)	4



Yika

MAT

Polycarbonato + ABS
Polycarbonate + ABS
Polycarbonate + ABS

DIF

Polycarbonato
Polycarbonate
Polycarbonate

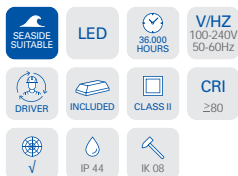
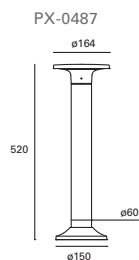
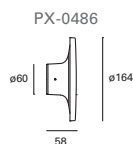

Code	Size	Color	Power	Kelvin	Rated flux	
PX-0486-NEG	L58xD164mm	● Black	7,9W	3000K	690 lm	12
PX-0487-NEG	H520xD164mm	● Black	7,9W	3000K	690 lm	6



Koral

MAT

Acero inoxidable AISI 202
AISI 202 Stainless steel
Acier inoxydable AISI 202

DIF

Polycarbonato
Polycarbonate
Polycarbonate



PX-0099

Ø78

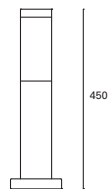

Ø128



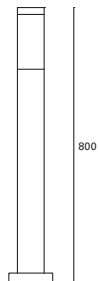

PX-0100

Ø78

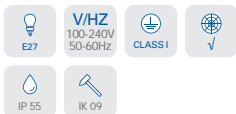

Ø128



Code	Size	Color	Power	
PX-0099-ANT	H450xD78mm	● Urban grey	Max. 15W (LED)	4
PX-0099-INO	H450xD78mm	● Stainless steel	Max. 15W (LED)	4
PX-0100-ANT	H800xD78mm	● Urban grey	Max. 15W (LED)	4
PX-0100-INO	H800xD78mm	● Stainless steel	Max. 15W (LED)	4

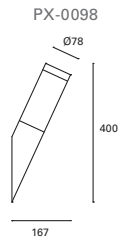

 E27	 V/HZ 100-240V 50-60Hz	 CLASS I	 ✓
 IP 55	 IK 09		

Code	Size	Color	Power	
PX-0098-INO	H400xD78mm	● Stainless steel	Max. 15W (LED)	12

Indoo

MAT Policarbonato
Polycarbonate
Polycarbonat

DIF Policarbonato
Polycarbonate
Polycarbonate

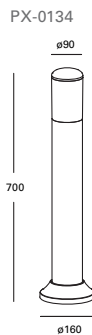
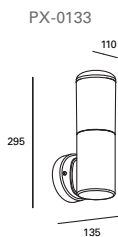

	Code	Size	Color	Power	
S	PX-0133-NEG	H295xL135mm	● Black	Max. 15W (LED)	12
	PX-0134-NEG	H700xD160mm	● Black	Max. 15W (LED)	6



Siros

MAT Aluminio inyectado
Injected aluminium
Aluminium injecté

DIF Cristal
Glass
Verre



PX-0025

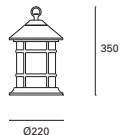

PX-0024

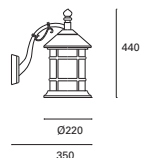

PX-0026

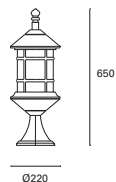

Code	Size	Color	Power	
PX-0025-OXI	D220xH350mm	● Rusty brown	Max. 15W (LED)	6
PX-0024-OXI	H440xL350mm	● Rusty brown	Max. 15W (LED)	4
PX-0026-OXI	H650xD220mm	● Rusty brown	Max. 15W (LED)	6

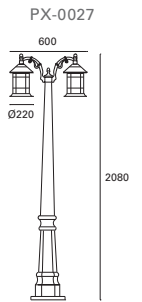

- E27
- V/HZ
100-240V
50-60Hz
- CLASS I
- 68°
- IP 23
- IK 02

Code	Size	Color	Power	
PX-0027-OXI	H2080xL600mm	● Rusty brown	2x Max. 15W (LED)	1

Afil

MAT

Aluminio
Aluminium
Aluminium

DIF

Cristal
Glass
Verre

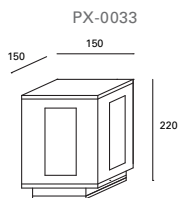
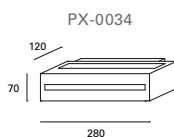

	Code	Size	Color	Power	
S	PX-0034-ANT	H70xL280mm	● Urban grey	Max. 15W (LED)	6
S	PX-0033-ANT	H220xL150mm	● Urban grey	Max. 15W (LED)	4



Box

MAT Cemento
Cement
Ciment

DIF Cristal
Glass
Verre

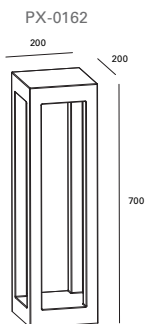
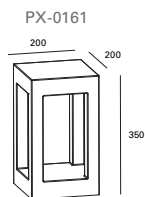
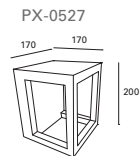

Acabado 100% cemento.

100% cement finish.

Finition 100 % ciment.



36.000 HOURS



V/HZ
220-240V
50-60Hz



DRIVER



INCLUDED



CLASS II



CRI
≥80



✓



IP 65



IK 10



0,1 M

	Code	Size	Color	Power	Kelvin	Rated flux	☐
S	PX-0527-CEM	H200xL170mm	● Cement	4W	4000K	380 lm	2
	PX-0161-CEM	H350xL200mm	● Cement	5,8W	4000K	580 lm	1
S	PX-0162-CEM	H700xL200mm	● Cement	5,8W	4000K	580 lm	1



Sirina NEW

MAT Aluminio
 Aluminium
 Aluminium

DIF Plástico
 Plastic
 Plastique

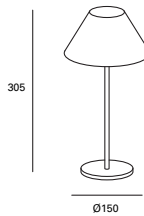

+INFO



- PRO**
- DIMMABLE**
- TOUCH**
- MAX. 12H
2000 mAh
- USB**
- 5V 1A**
- LED**
- 36.000 HOURS
- CLASS III**
- CRI ≥80**
- ✓
- IP 54
- IK 10

Code	Color	Power	Kelvin	Rated flux	
PX-0566-NEG	● Black	4W	3000K	506 lm	12



3 intensidades lumínicas.
3 brightness settings.
3 intensités lumineuses.

Treta NEW

- MAT** Aluminio Aluminium Aluminium
- DIF** Policarbonato Polycarbonate Polycarbonate

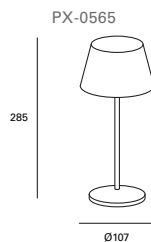
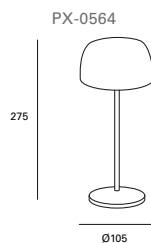

Carga por inducción magnética.
Charging by magnetic induction.
Charge par induction magnétique.



+INFO PX-0564



+INFO PX-0565



- PRO**
- DIMMABLE**
- CCT**
- TOUCH**
- MAX. 12H**
2000 mAh
- USB**
- 5V 1A**
- LED**
- CLASS III**
- IP 54**
- IK 10**

Code	Size	Color	Power	Kelvin	Rated flux	
PX-0564-NEG	H275xD105mm	● Black	2W	2700K, 4000K	250 lm	8
PX-0565-NEG	H285xD107mm	● Black	2W	2700K, 4000K	250 lm	8



Selección de color 2700k y 4000k.
Color selection 2700k and 4000k.
Choix des couleurs 2700k et 4000k.



Regulación de intensidades lumínicas.
Light intensity control.
Variation de l'intensité lumineuse.

Deco

- MAT** Acero Steel Acier
- DIF** Policarbonato Polycarbonate Polycarbonate

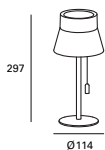

Tirador para ajustar niveles de luminosidad.

Handle to adjust brightness levels.

Poignée permettant de régler les niveaux de luminosité.

+INFO



SOLAR	DIMMABLE	MAX. 14h 2000 mAh	USB
5V 1A	LED	36.000 HOURS	CLASS III
CRI ≥80	IP 54		

Code	Color	Power	Kelvin	Rated flux	
PX-0263-NEG	● Black	2,8W	3000K	280 lm	8



Night

- MAT** Aluminio
Aluminium
Aluminium
- DIF** Policarbonato
Polycarbonate
Polycarbonate

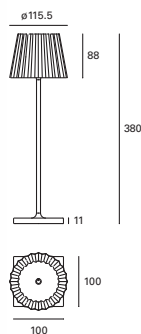

- TOUCH
- LED
- MAX. 9H
2200 mAh
- USB
- 36.000 HOURS
- V/HZ
100-240V
50-60Hz
- LED DRIVER
- INCLUDED
- CLASS II
- CRI ≥80
- IP 54
- IK 10

Code	Color	Power	Kelvin	Rated flux	⊞
DE-0474-BLA	○ White	6,4W	3000K	280 lm	6
S DE-0474-NEG	● Black	6,4W	3000K	280 lm	6



Mush

- MAT** Aluminio
Aluminium
Aluminium
- DIF** Policarbonato
Polycarbonate
Polycarbonate



★
 ON/OFF táctil.
 ON/OFF touch switch.
 ON/OFF tactile.

★
 Cable USB tipo C
 de 1 metro incluido.
 1 metre USB C-type cable
 included.
 Câble USB type C
 de 1 mètre fourni.

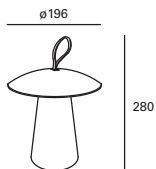

DIMMABLE	TOUCH	MAX. 120H 4400 mAh	USB
5V 1A	LED	36.000 HOURS	DRIVER
CLASS III	CRI ≥80	IP 54	

Code	Color	Power	Kelvin	Rated flux	
PX-0528-BLA	○ White	2W	3000K	200 lm	4

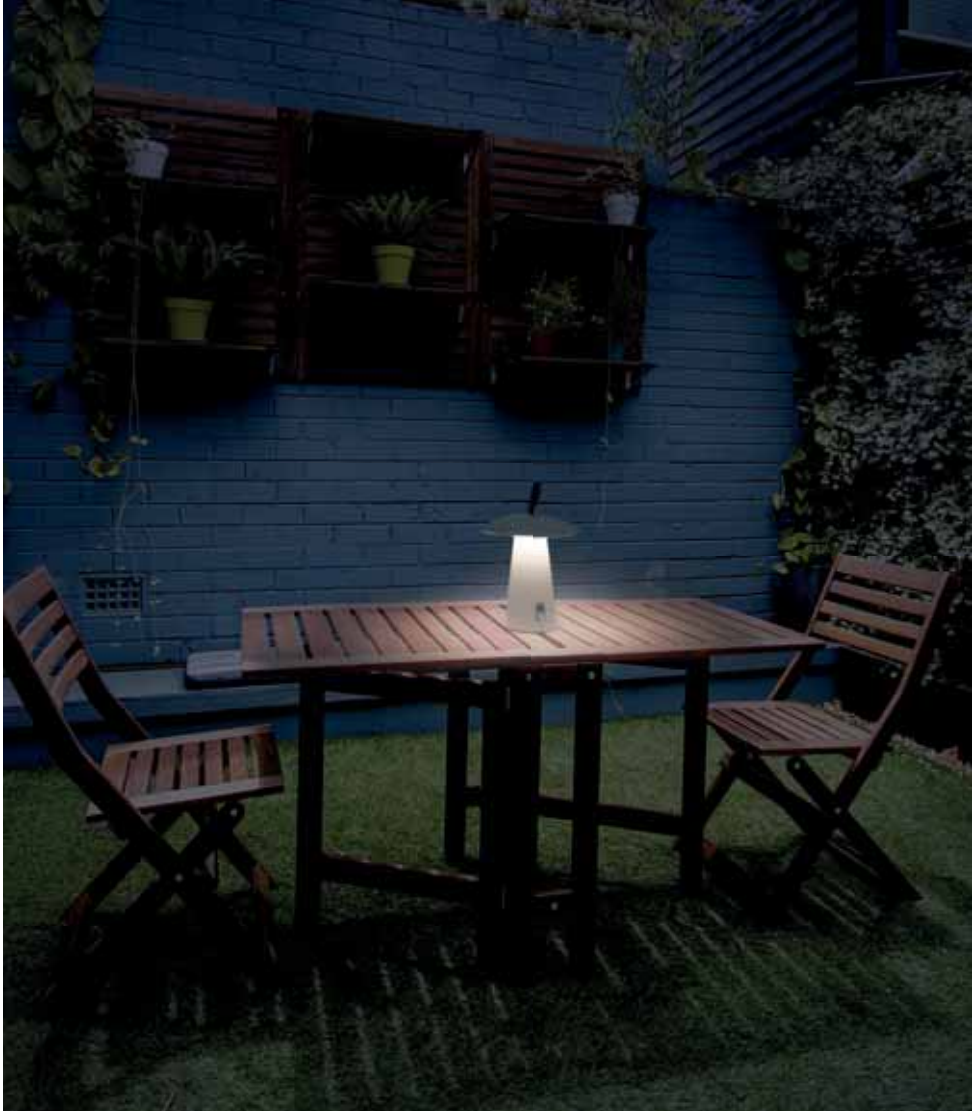

10%

40%

100%



3 intensidades lumínicas.
Duración de la batería:
6,5h 100%, 15h 40% y 80h 10%.

3 brightness settings. Battery
duration:
6,5h 100%, 15h 40% and 80h 10%.

3 intensités lumineuses.
Durée de la batterie:
6,5h 100%, 15h 40% et 80h 10%.

Moon

- MAT** ABS
ABS
ABS
- DIF** Plástico
Plastic
Plastique

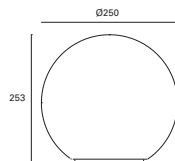

Code	Color	Power	
PX-0478-BLA	○ White	Max. 15W (LED)	8

Sphere

- MAT** Policarbonato
Polycarbonate
Polycarbonat
- DIF** Polietileno
Polyethylene
Polyéthylène

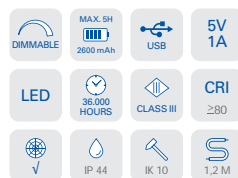
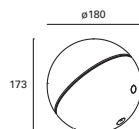

	Code	Color	Power	Kelvin	Rated flux	
S	DE-0490-NEG	● Black	1,5W	2700K	90 lm	8

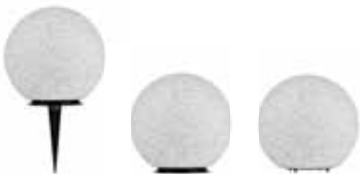

PX-0478



Incluye base para fijar sobre muros o superficies duras.

Includes base for attaching to tops of walls or hard surfaces.

Comprend une base pour fixation sur bornes ou surfaces dures.



Decorativo
Decorative
Décoratif

Riba

- MAT** Acero
Steel
Acier
- DIF** Madera
Wood
Bois

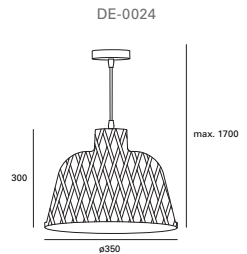
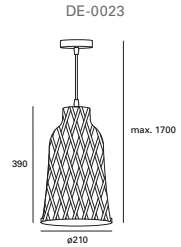

Regulable en altura hasta 170 cm.
 Height adjustable up to 170 cm.
 Réglable en hauteur jusqu'à 170 cm.

-
-
-
-
-

IP: 20

Code	Size	Color	Power	
DE-0023-NEG	D210xH390mm	● Black	Max. 15W (LED)	1
DE-0024-NEG	D250xH300mm	● Black	Max. 15W (LED)	1



Meg

MAT Madera
Wood
Bois

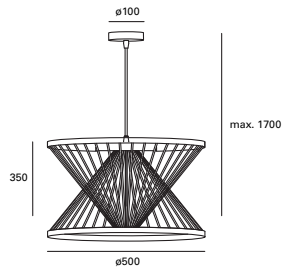

Regulable en altura hasta 170 cm.

Height adjustable up to 170 cm.

Réglable en hauteur jusqu'à 170 cm.



Code Color Power 

S DE-0010-MAD ● Lightwood Max. 15W (LED) 1



Lampa

- MAT** Madera
Wood
Bois
- DIF** Textil y Acrílico
Textile and Acrylic
Textile et Acrylique

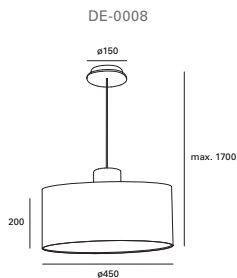
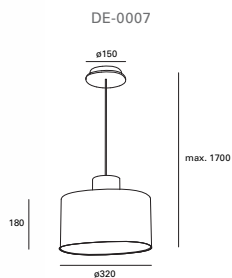

*
 Madera natural.
 Natural wood.
 Bois naturel.

- E27
- V/HZ 100-240V 50-60HZ
- CLASS I
- V
- IP 20

Code	Size	Color	Power	
DE-0007-MAD	D320xH180mm	● Wood	Max. 15W (LED)	1
S DE-0008-MAD	D450xH200mm	● Wood	Max. 15W (LED)	1



Maya

MAT

Acero
Steel
Acier

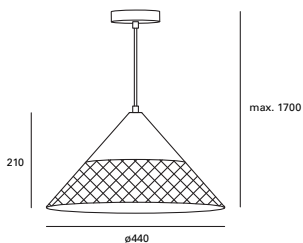

Regulable en altura hasta 170 cm.

Height adjustable up to 170 cm.

Réglable en hauteur jusqu'à 170 cm.



Code Color Power

S DE-0011-NEG ● Black Max. 15W (LED) 1



Bowl

MAT Acero
 Steel
 Acier

*
 Regulable en altura hasta 170 cm.
 Height adjustable up to 170 cm.
 Réglable en hauteur jusqu'à 170 cm.

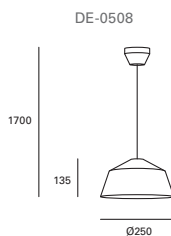

*
 Regulable en altura hasta 182 cm.
 Height adjustable up to 182 cm.
 Réglable en hauteur jusqu'à 182 cm.

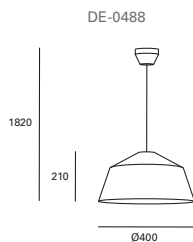

E27
 V/HZ 100-240V 50-60HZ
 CLASS I
 V
 IP 20

	Code	Size	Color	Power	
S	DE-0508-NEG	D250xH135mm	● Black	Max. 15W (LED)	4
S	DE-0488-NEG	D400xH210mm	● Black	Max. 15W (LED)	2



Nube

MAT

Acero y madera
Steel and wood
Acier et bois

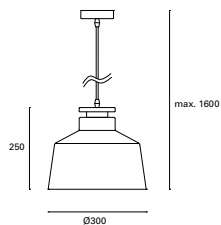

Regulable en altura hasta 160 cm.

Height adjustable up to 160 cm.

Réglable en hauteur jusqu'à 160 cm.



Code	Color	Power	⊞
DE-0233-BLA	○ White	Max. 15W (LED)	4



Kea

- MAT** Acero
Steel
Acier
- DIF** Cristal
Glass
Verre

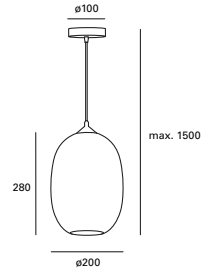

Regulable en altura hasta 150 cm.
 Height adjustable up to 150 cm.
 Réglable en hauteur jusqu'à 150 cm.

- E27
- V/HZ 100-240V 50-60Hz
- CLASS I
- V
- IP20

Code **Color** **Power**

S DE-0022-NEG ● Black Max. 15W (LED) 4



Vira

MAT

Acero
Steel
Acier

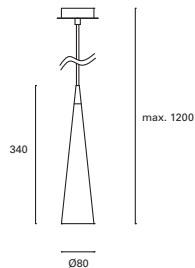

Regulable en altura hasta 120 cm.

Height adjustable up to 120 cm.

Réglable en hauteur jusqu'à 120 cm.



Code	Color	Power	
DE-0180-BLA	○ White	Max. 8W (LED)	12
DE-0180-NEG	● Black	Max. 8W (LED)	12

Era

MAT

Aluminio
Aluminium
Aluminium

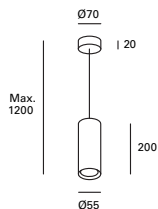

Code	Color	Power	
TC-0079-BLA	○ White	Max. 8W (LED)	30
TC-0079-NEG	● Black	Max. 8W (LED)	30



Thin

- MAT** Aluminio
Aluminium
Aluminium
- DIF** Acrílico
Acrylic
Acrylique

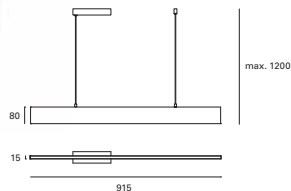

Iluminación Up/down.

Up lighting and down lighting.

Éclairage vers le haut et vers le bas.

LED 36,000 HOURS V/HZ 220-240V 50-60Hz DRIVER

INCLUDED CLASS II CRI ≥80 V

IP 20

	Code	Color	Power	Kelvin	Rated flux	⊞
S	DE-0510-NEG	● Black	25,9W	3000K	1920 lm	6
S	DE-0510-BLA	○ White	25,9W	3000K	1920 lm	6



Stac NEW

MAT

Aluminio
 Aluminium
 Aluminium

DIF

Polycarbonato
 Polycarbonate
 Polycarbonate



TC-0105

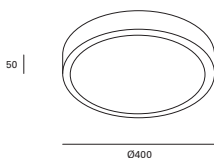

TC-0106

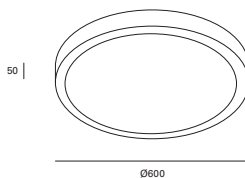

+INFO



- PRO**
- LED**
- 96,000 HOURS
- VHZ
220-240V
50-60Hz
- LED DRIVER
- INCLUDED
- CLASS I
- CRI ≥80
- CONFORT VISUAL
- UGR <22
- 120°
- IP 20

Code	Size	Color	Power	Kelvin	Rated flux	
TC-0105-BLA	D400xH50mm	○ White	18,3W	4000K	2550 lm	10
TC-0106-BLA	D600xH50mm	○ White	42W	4000K	4500 lm	5

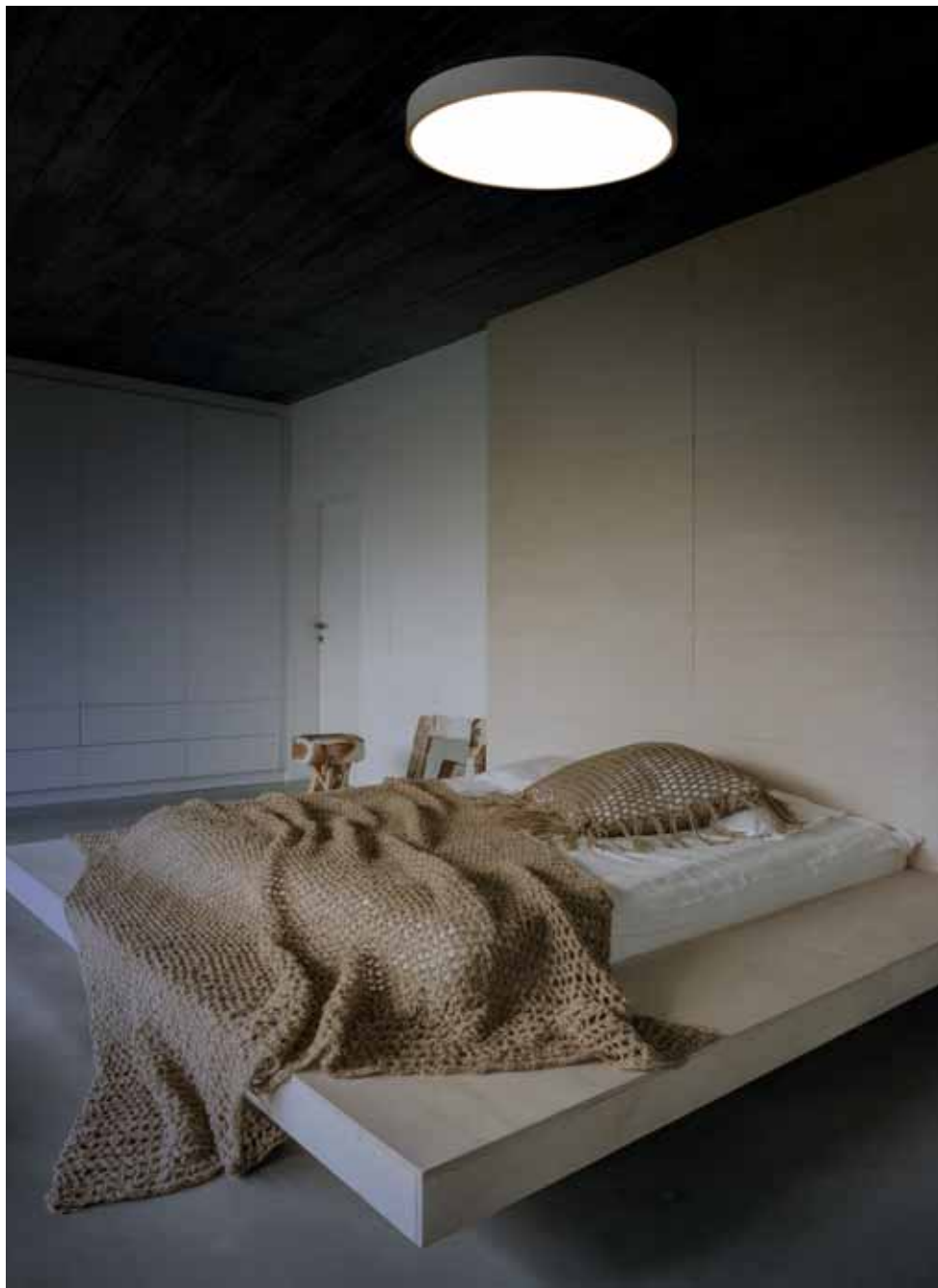

Tempo wood

MAT Aluminio
 Aluminium
 Aluminium

DIF Acrílico
 Acrylic
 Acrylique

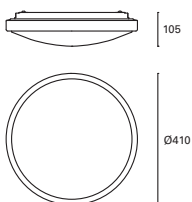

LED	36.000 HOURS	V/HZ 100-240V 50-60Hz	(LED)
DRIVER	INCLUDED	CLASS II	CRI ≥80
IP 44			

Code	Color	Power	Kelvin	Rated flux	
S DE-0314-MAD	● Wood	25,3W	3000K	2300 lm	5



Tempo

MAT Aluminio
 Aluminium
 Aluminium

DIF Acrílico
 Acrylic
 Acrylique

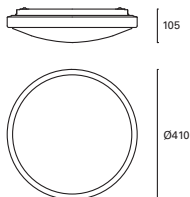

LED	36.000 HOURS	V/HZ 100-240V 50-60Hz	
DRIVER	INCLUDED	CLASS I	V
CRI ≥80	IP 44		

Code	Color	Power	Kelvin	Rated flux	
S DE-0314-ALU	● Aluminium	25,3W	3000K	2300 lm	5



Ola

- MAT** Acero
Steel
Acier
- DIF** Acrílico
Acrylic
Acrylique

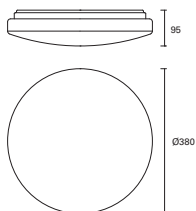

LED	36.000 HOURS	V/HZ 100-240V 50-60Hz	LED
DRIVER	INCLUDED	CLASS I	CRI ≥80
✓	IP 23		

Code	Color	Power	Kelvin	Rated flux	
DE-0198-BLA	○ White	22,8W	3000K	2400 lm	10



Farrow

MAT Acero
Steel
Acier

DIF Cristal
Glass
Verre

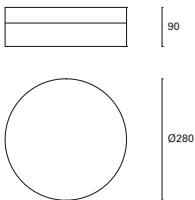

Code DE-0199-BLA **Color** ○ White **Power** 2x Max. 15W (LED)



Era

- MAT** Aluminio
Aluminium
Aluminium
- DIF** Policarbonato
Polycarbonate
Polycarbonate

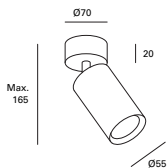

- GU10
- VHZ 100-240V 50-60Hz
- CLASS I
- ✓
- 355°
- 90°
- IP 20

Code	Size	Color	Power	
TC-0078-BLA	H165xD55mm	○ White	Max. 8W (LED)	40
TC-0078-NEG	H165xD55mm	● Black	Max. 8W (LED)	40



Keeper

MAT

Acero
Steel
Acier

DE-0479

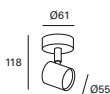

DE-0480

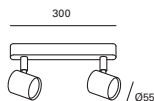

DE-0481

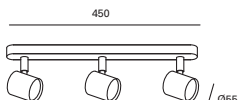

Code	Size	Color	Power	☰
DE-0479-BLA	D61xH118mm	○ White	Max. 8W (LED)	24
DE-0479-NEG	D61xH118mm	● Black	Max. 8W (LED)	24
DE-0480-BLA	L300xH118mm	○ White	2x Max. 8W (LED)	12
DE-0480-NEG	L300xH118mm	● Black	2x Max. 8W (LED)	12
DE-0481-BLA	L450xH118mm	○ White	3x Max. 8W (LED)	12
DE-0481-NEG	L450xH118mm	● Black	3x Max. 8W (LED)	12





Safran

MAT

Acero
Steel
Acier

DE-0225

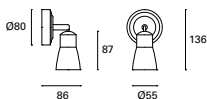

DE-0226

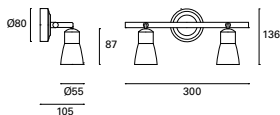

DE-0227

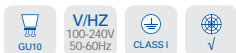
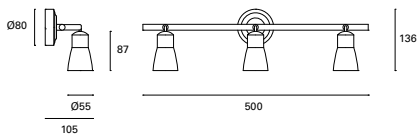
V/HZ
100-240V
50-60Hz

355°



90°



IP 20

Code	Size	Color	Power	☰
DE-0225-MAR	D80xH136mm	● Brown	Max. 8W (LED)	24
DE-0226-MAR	L300xH136mm	● Brown	2x Max. 8W (LED)	12
DE-0227-MAR	L500xH136mm	● Brown	3x Max. 8W (LED)	12



Logos

MAT

Acero
Steel
Acier

DIF

Policarbonato
Polycarbonate
Polycarbonate

DE-0014



DE-0015

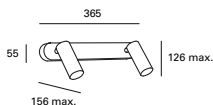

DE-0016

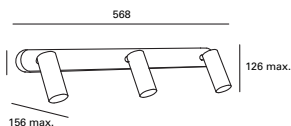

Code	Size	Color	Power	Kelvin	Rated flux	☐
DE-0014-BLA	D100xH112mm	○ White	4,2W	3000K	420 lm	24
DE-0014-NEG	D100xH112mm	● Black	4,2W	3000K	420 lm	24
DE-0015-BLA	L365xH126mm	○ White	8,4W	3000K	840 lm	12
DE-0015-NEG	L365xH126mm	● Black	8,4W	3000K	840 lm	12
DE-0016-BLA	L568xH126mm	○ White	12,6W	3000K	1260 lm	12
DE-0016-NEG	L568xH126MM	● Black	12,6W	3000K	1260 lm	12



Colo NEW

- MAT** Aluminio
Aluminium
Aluminium
- DIF** Policarbonato
Polycarbonate
Polycarbonate

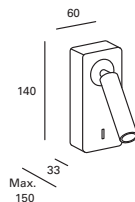

+INFO



PRO	LED	36.000 HOURS	V/HZ 220-240V 50-60Hz
DRIVER	INCLUDED	CLASS I	CRI ≥80
✓	45°	350°	IP 20

Code	Color	Power	Kelvin	Rated flux	☐
DE-0116-BLA	○ White	3,4W	3000K	184 lm	50
DE-0116-NEG	● Black	3,4W	3000K	184 lm	50



Era

MAT

Aluminio
 Aluminium
 Aluminium

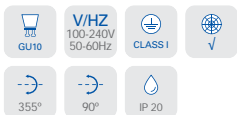
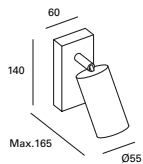

Code	Color	Power	⊞
TC-0080-BLA	○ White	Max. 8W (LED)	30
TC-0080-NEG	● Black	Max. 8W (LED)	30



Mine NEW

MAT Aluminio
 Aluminium
 Aluminium

DIF Policarbonato
 Polycarbonate
 Polycarbonate

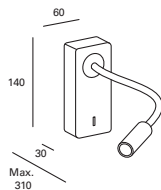

+INFO



PRO	LED	36.000 HOURS	V/HZ 220-240V 50-60Hz
DRIVER	INCLUDED	CLASS I	CRI ≥80
✓	180°	180°	IP 20

Code	Color	Power	Kelvin	Rated flux	ⓘ
DE-0117-BLA	○ White	3,4W	3000K	184 lm	30
DE-0117-NEG	● Black	3,4W	3000K	184 lm	30



Crobat

MAT

Polycarbonato
 Polycarbonate
 Polycarbonate

DIF

Polycarbonato
 Polycarbonate
 Polycarbonate

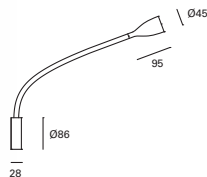

Smax = 420

LED	36.000 HOURS	V/HZ 100-240V 50-60HZ	(LED)
DRIVER	INCLUDED	CLASS II	CRI ≥80
IP 20			

Code	Color	Power	Kelvin	Rated flux	
DE-0268-BLA	○ White	4,3W	3000K	450 lm	12
DE-0268-NEG	● Black	4,3W	3000K	450 lm	12



Bas

MAT Acero
 Steel
 Acier

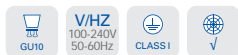
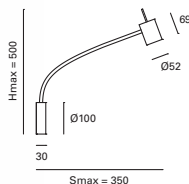

Code	Color	Power	⊞
DE-0442-SAT	● Satin nickel	Max. 8W (LED)	20

Llit

MAT Acero
 Steel
 Acier

DIF PMMA
 PMMA
 PMMA



	Code	Color	Power	Kelvin	Rated flux	⊞
S	DE-0002-SAT	● Satin nickel	4,7W	4000K	445 lm	3



Aura NEW

MAT Aluminio
 Aluminium
 Aluminium

DIF Textil
 Textile
 Textile

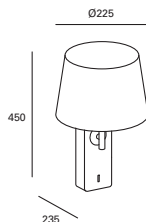

+INFO



Code	Color	Power	
DE-0118-BLA	○ White	Max. 15W (LED)	8
DE-0118-NEG	● Black	Max. 15W (LED)	8



Lyon

MAT Acero
Steel
Acier

DIF Tèxtil
Textile
Textile

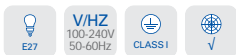
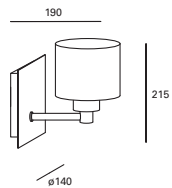

Code	Color	Power	
DE-0003-SAT	● Satin nickel	Max. 15W (LED)	4



Janet NEW

MAT Aluminio
 Aluminium
 Aluminium

DIF Textil
 Textile
 Textile

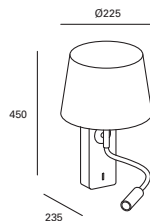

+INFO



PRO	LED	E27	36.000 HOURS
V/HZ 220-240V 50-60Hz	DRIVER	INCLUDED	CLASS I
CRI ≥80	180°	180°	180°
IP 20			

Code	Color	Power	Kelvin	Rated flux	
DE-0115-BLA	○ White	18,4W 3,4W(LED)+Max.15W(E27)	3000K	184 lm	8
DE-0115-NEG	● Black	18,4W 3,4W(LED)+Max.15W(E27)	3000K	184 lm	8



Ander NEW

MAT Aluminio y Acero
 Aluminium and Steel
 Aluminium et Acier

DIF Acrílico
 Acrylic
 Acrylique

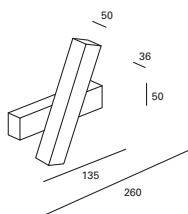

+INFO



PRO	LED	36.000 HOURS	V/HZ 220-240V 50-60Hz
DRIVER	INCLUDED	CLASS II	CRI ≥80
✓	350°	IP 20	

Code	Color	Power	Kelvin	Rated flux	Ⓜ
DE-0123-BLA	○ White	6,6W	3000K	720 lm	20



Roc NEW

MAT Acero
 Steel
 Acier

DIF Policarbonato
 Polycarbonate
 Polycarbonate

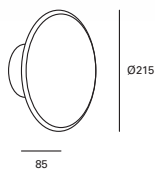

+INFO



PRO	LED	36.000 HOURS	V/HZ 220-240V 50-60Hz
DRIVER	INCLUDED	CLASS II	CRI ≥80
✓	360°	45°	IP 20

Code	Color	Power	Kelvin	Rated flux	
DE-0114-BLA	○ White	7,3W	3000K	770 lm	6



370 Interior | Decorativo | Applique de pared
Indoor | Decorative | Wall fixture
Intérieur | Décoratif | Applique

Keep

MAT Aluminio
Aluminium
Aluminium

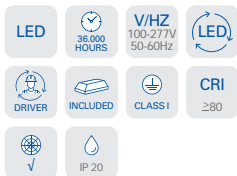
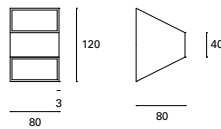
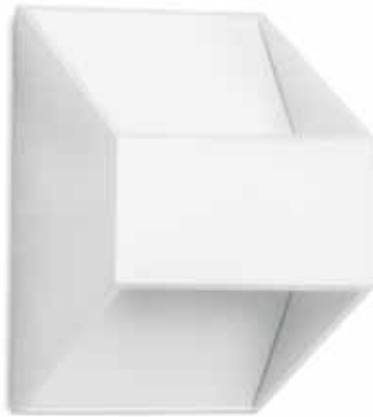

Code	Color	Power	Kelvin	Rated flux	
DE-0229-BLA	○ White	5,8W	3000K	420 lm	20



Toppi

MAT Aluminium
 Aluminium
 Aluminium

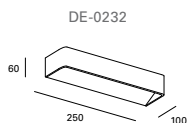
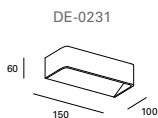

- LED
- 36,000 HOURS
- V/HZ
100-240V
50-60HZ
- LED
- DRIVER
- INCLUDED
- CRI
≥80
- √
- IP 20

DE-0231



DE-0232



Code	Size	Color	Power	Kelvin	Rated flux	
DE-0231-BLA	W150xH60mm	○ White	5,8W	3000K	530 lm	20
DE-0232-BLA	W250xH60mm	○ White	11,5W	3000K	1100 lm	20



Thin

MAT Aluminio
 Aluminium
 Aluminium

DIF Acrílico
 Acrylic
 Acrylique

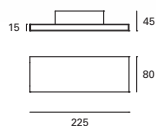
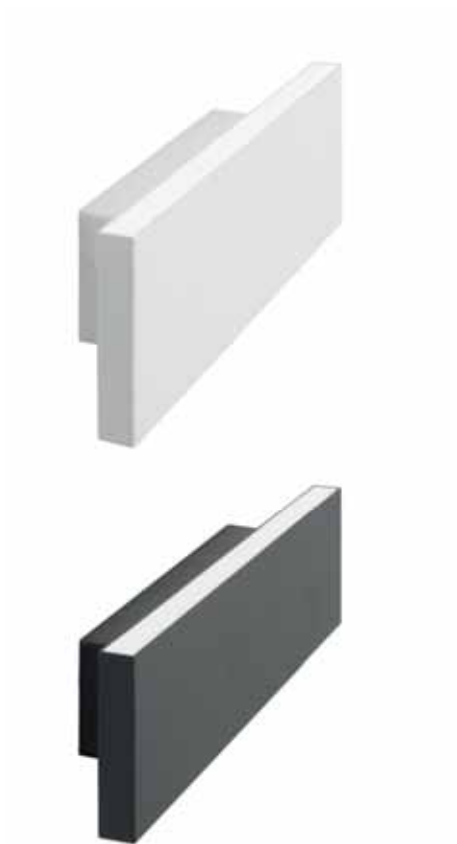

LED
 36,000 HOURS
 V/HZ 220-240V 50-60Hz
 DRIVER
 INCLUDED
 CLASS II
 CRI ≥80
 IP 20

Code	Color	Power	Kelvin	Rated flux	⊞
DE-0509-BLA	○ White	7,8W	3000K	860 lm	10
DE-0509-NEG	● Black	7,8W	3000K	860 lm	10



376 Interior | Decorativo | Applique de pared
Indoor | Decorative | Wall fixture
Intérieur | Décoratif | Applique

Meds NEW

MAT

Aluminio
Aluminium
Aluminium

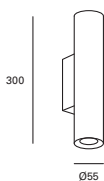

+INFO



Code	Color	Power	
DE-0136-NEG	● Black	2x Max. 8W (LED)	20



Glass

- MAT** Acero
Steel
Acier
- DIF** Cristal
Glass
Verre

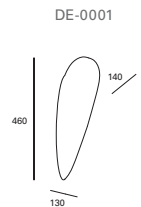
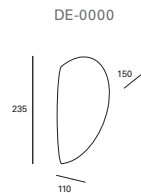

- E27
- V/HZ 100-240V 50-60Hz
- CLASS I
- ✓
- IP 20

	Code	Size	Color	Power	
S	DE-0000-BLA	H235xW110mm	○ White	Max. 15W (LED)	6
S	DE-0001-BLA	H460xW130mm	○ White	Max. 15W (LED)	6

Niza

- MAT** Acero
Steel
Acier
- DIF** Cristal
Glass
Verre

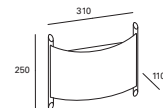

- E27
- V/HZ 100-240V 50-60Hz
- CLASS I
- ✓
- IP 20

	Code	Color	Power	
	DE-0004-SAT	● Satin nickel	2x Max. 15W (LED)	6



Meds NEW

MAT

Aluminio
Aluminium
Aluminium

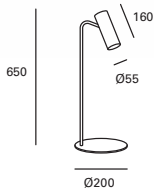

+INFO



Code	Color	Power	
DE-0134-NEG	● Black	Max. 8W (LED)	4



Tender

MAT Policarbonato y Acero
 Polycarbonate and Steel
 Polycarbonate et Acier

DIF Policarbonato
 Polycarbonate
 Polycarbonate

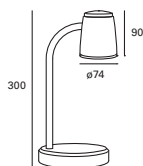

LED 36,000 HOURS V/Hz 100-240V 50-60Hz (LED)
 DRIVER INCLUDED CLASS II CRI ≥80
 IP 20

Code	Color	Power	Kelvin	Rated flux	
S DE-0500-NEG	● Black	4W	3000K	550 lm	6

Ding

MAT Aluminio
 Aluminium
 Aluminium

DIF Policarbonato
 Polycarbonate
 Polycarbonate

★ Puerto USB de 1 amperio de carga máxima.

1 amp maximum load USB Port.

Port USB de 1 ampère de charge maximale.

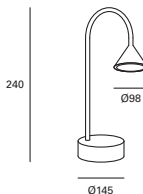

TOUCH USB LED 36,000 HOURS
 V/Hz 100-240V 50-60Hz (LED) DRIVER INCLUDED CLASS II CRI ≥80
 IP 20

Code	Color	Power	Kelvin	Rated flux	
DE-0271-BLA	○ White	6,6W	3000K	520 lm	6
DE-0271-NEG	● Black	6,6W	3000K	520 lm	6



Touch

- MAT** Aluminio
Aluminium
Aluminium
- DIF** Policarbonato
Polycarbonate
Polycarbonate

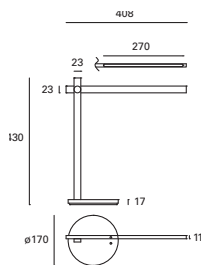

 El código DE-0492-BLA
 incluye cargador inalámbrico.

The code DE-0492-BLA
 includes wireless charger.

Le code DE-0492-BLA comprend
 un chargeur sansfil.

- DIMMABLE**
- CCT**
- TOUCH**
- LED**
- 36.000 HOURS**
- V/HZ 100-240V 50-60Hz**
- DRIVER INCLUDED**
- CLASS II**
- CRI ≥80**
- 180°**
- IP 20**

Code	Color	Power	Kelvin	Rated flux	ⓘ
DE-0477-BLA	○ White	6,4W	3000K,4300K,6500K	680 lm*	6
S DE-0492-BLA	○ White	6,4W	3000K,4300K,6500K	680 lm*	4

* Valor basado en 4000K. Value based on 4000K. Valeur basée sur 4000K.



3 temperaturas de color (3000K/4300K/6500K).
 3 colour temperatures (3000K/4300K/6500K).
 3 températures de couleur (3000K/4300K/6500K).

3 intensidades luminicas.
 3 brightness settings.
 3 intensités lumineuses.

Romi

- MAT Acero
Steel
Acier
- DIF Tèxtil
Textile
Textile

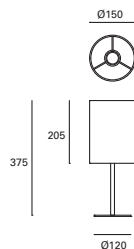

- E27
- VHZ 100-240V
50-60Hz
- CLASS II
- IP 20

	Code	Color	Power	
S	DE-0383-SAT	● Satin nickel	Max. 15W (LED)	6

Nuts

- MAT Madera
Wood
Bois
- DIF Tèxtil
Textile
Textile

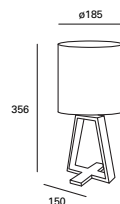

*
 Madera natural.
 Natural wood.
 Bois naturel.

- E27
- VHZ 100-240V
50-60Hz
- CLASS II
- IP 20

	Code	Color	Power	
	DE-0020-BLA	○ White	Max. 15W (LED)	12
	DE-0020-GRI	● Grey	Max. 15W (LED)	12



Night

- MAT** Aluminio
Aluminium
Aluminium
- DIF** Policarbonato
Polycarbonate
Polycarbonate

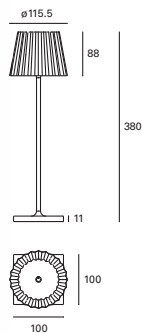

- TOUCH
- MAX. 9H
2200 mAh
- USB
- LED
- 36.000 HOURS
- V/HZ
100-240V
50-60Hz
- LED DRIVER
- INCLUDED
- CLASS II
- CRI ≥80
- IP 54
- IK 10

Code	Color	Power	Kelvin	Rated flux	⊞
DE-0474-BLA	○ White	6,4W	3000K	280 lm	6
S DE-0474-NEG	● Black	6,4W	3000K	280 lm	6



Mush

- MAT** Aluminio
Aluminium
Aluminium
- DIF** Policarbonato
Polycarbonate
Polycarbonate



- ★ ON/OFF táctil.
ON/OFF touch switch.
ON/OFF tactile.

- ★ Cable USB tipo C de 1 metro incluido.
1 metre USB C-type cable included.
Câble USB type C de 1 mètre fourni.

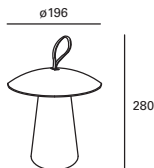

DIMMABLE	TOUCH	MAX. 6.5H 5200 mAh	USB
LED	36,000 HOURS	5V 1A	DRIVER
INCLUDED	CLASS III	CRI ≥80	IP 65

Code	Color	Power	Kelvin	Rated flux	
PX-0528-BLA	○ White	2W	3000K	200 lm	4



10%

40%

100%



3 intensidades lumínicas.
Duración de la batería:
6,5h 100%, 15h 40% y 80h 10%.

3 brightness settings.
Battery duration:
6,5h 100%, 15h 40% and 80h 10%.

3 intensités lumineuses.
Durée de la batterie:
6,5h 100%, 15h 40% et 80h 10%.

Magnet

MAT Acero y aluminio
 Stainless and aluminium
 Acier et aluminium

DIF Policarbonato
 Polycarbonate
 Polycarbonate



Cabezal orientable y extraíble gracias a su sistema de fijación magnético. Cable USB tipo C de 1,2 metros incluido.

Adjustable, removable head thanks to its magnetic fixing system. 1.2 metres USB C-type cable included."

Tête orientable et amovible grâce à son système de fixation magnétique. Câble USB type C de 1,2 mètre fourni.

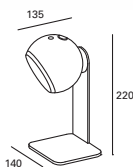

DIMMABLE	MAX. 20H 2600 mAh	USB	5V 1A
LED	36,000 HOURS	LED	DRIVER
CLASS III	CRI ≥80	120°	✓
270°	270°	IP 20	IK 02

Code	Color	Power	Kelvin	Rated flux	
S PX-0529-NEG	● Black	1,5W	2700K	180 lm	8



20h - 25%

10h - 50%

5 - 100%



3 intensidades lumínicas.

3 brightness settings.

3 intensités lumineuses.

Meds NEW

MAT

Aluminio
Aluminium
Aluminium

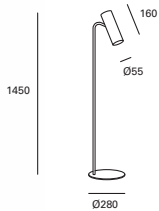
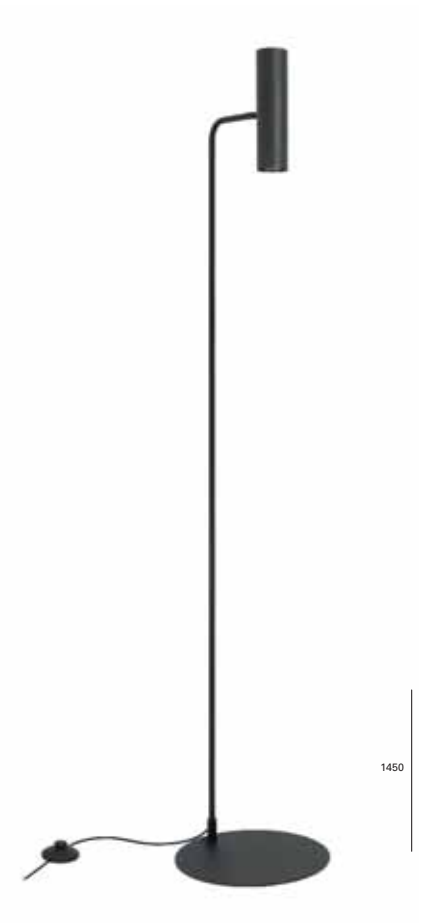

+INFO



Code	Color	Power	⊞
DE-0135-NEG	● Black	Max. 8W (LED)	4



Ding

MAT

Aluminio y acero
 Aluminium and steel
 Aluminium et acier

DIF

Polycarbonato
 Polycarbonate
 Polycarbonate



LED	36.000 HOURS	V/HZ 100-240V 50-60Hz	(LED)
DRIVER	INCLUDED	CLASS II	CRI ≥80
✓	360°	IP 20	

Code	Color	Power	Kelvin	Rated flux	☐
DE-0272-BLA	○ White	6,6W	3000K	520 lm	4
S DE-0272-NEG	● Black	6,6W	3000K	520 lm	4



Lampa

- MAT** Acero y Madera
Steel and Wood
Acier et Bois
- DIF** Textil y Acrílico
Textile and Acrylic
Textile et Acrylique

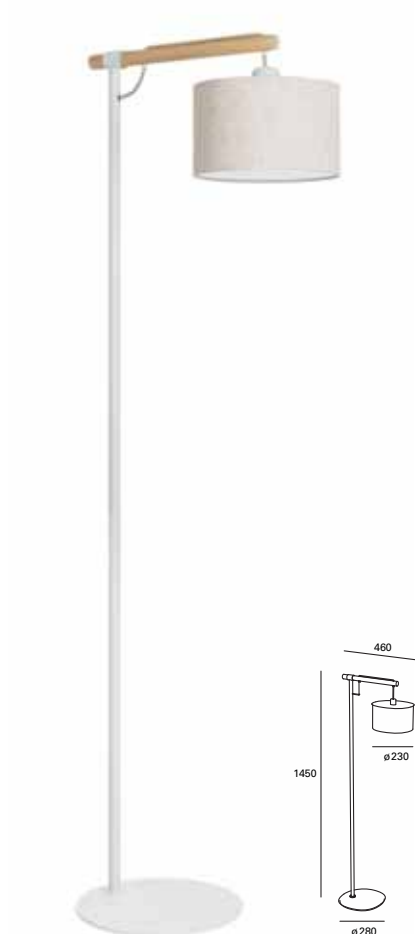

Madera natural.
 Natural wood.
 Bois naturel.

- E27
- V/HZ 100-240V 50-60Hz
- CLASS II
- V
- IP:20

	Code	Color	Power	
S	DE-0006-MAD	● Wood	Max. 15W (LED)	4



Meds NEW

MAT Aluminio
 Aluminium
 Aluminium

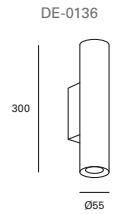

+INFO



+INFO



DE-0136



DE-0134

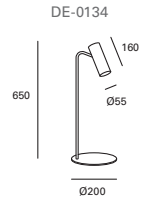

Code	Size	Color	Power	
DE-0136-NEG	H300xD55mm	● Black	2x Max. 8W (LED)	20
DE-0134-NEG	H650xD200mm	● Black	Max. 8W (LED)	4

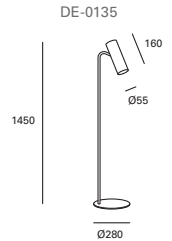
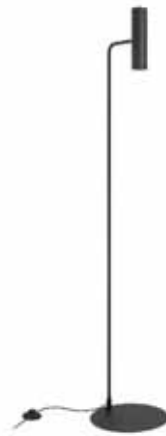

+INFO



Code	Size	Color	Power	
DE-0135-NEG	D280xH1450mm	● Black	Max. 8W (LED)	4

Ding

MAT Aluminio y acero
 Aluminium and steel
 Aluminium et acier

DIF Policarbonato
 Polycarbonate
 Polycarbonate

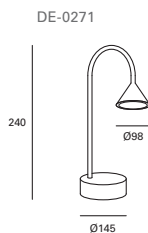

DE-0271



Puerto USB de 1 amperio de carga máxima.

1 amp maximum load USB Port.

Port USB de 1 ampère de charge maximale.

- LED
- 36,000 HOURS
- V/HZ
100-240V
50-60Hz
- LED
- DRIVER
- INCLUDED
- CLASS II
- CRI
≥80
- TOUCH
- 360°
- IP 20

DE-0271

- TOUCH
- USB

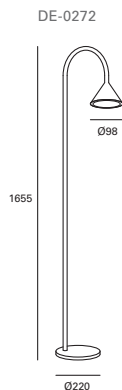
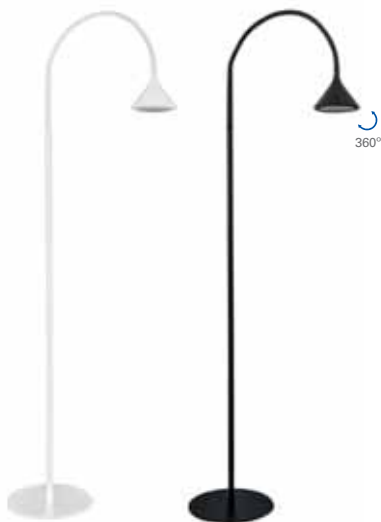

Code	Size	Color	Power	Kelvin	Rated flux	
DE-0271-BLA	H740XD145mm	○ White	6,6W	3000K	520 lm	6
DE-0271-NEG	H740XD145mm	● Black	6,6W	3000K	520 lm	6
DE-0272-BLA	H1655XD220mm	○ White	6,6W	3000K	520 lm	4
S DE-0272-NEG	H1655XD220mm	● Black	6,6W	3000K	520 lm	4



Era

- MAT** Aluminio
Aluminium
Aluminium
- DIF** Policarbonato
Polycarbonate
Polycarbonate

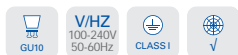
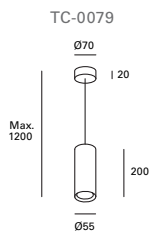
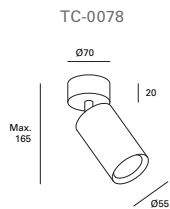

TC-0078



Code	Size	Color	Power	
TC-0078-BLA	H165xD55mm	○ White	Max. 8W (LED)	40
TC-0078-NEG	H165xD55mm	● Black	Max. 8W (LED)	40
TC-0079-BLA	H200xD55mm	○ White	Max. 8W (LED)	30
TC-0079-NEG	H200xD55mm	● Black	Max. 8W (LED)	30

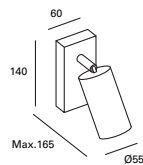

Code	Color	Power	⊞
TC-0080-BLA	○ White	Max. 8W (LED)	30
TC-0080-NEG	● Black	Max. 8W (LED)	30

Lampa

- MAT Madera
Wood
Bois
- DIF Textil y Acrílico
Textile and Acrylic
Textile et Acrylique

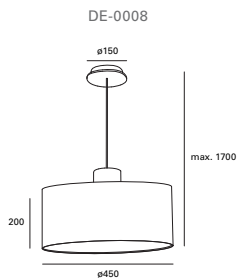
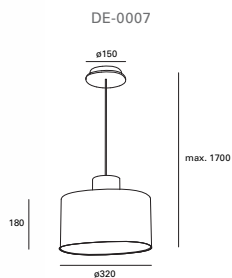

Madera natural.
 Natural wood.
 Bois naturel.

E27

V/HZ
100-240V
50-60Hz

CLASS I

V

IP_20

Code	Size	Color	Power	
DE-0007-MAD	D320xH180mm	● Wood	Max. 15W (LED)	1
S DE-0008-MAD	D450xH200mm	● Wood	Max. 15W (LED)	1

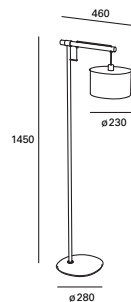

Madera natural.
Natural wood.
Bois naturel.

E27	100-240V 50-60Hz	CLASS II	
IP 20			

	Code	Color	Power	
S	DE-0006-MAD	● Wood	Max. 15W (LED)	4

Feu NEW

- MAT** Aluminio
Aluminium
Aluminium
- DIF** Cristal
Glass
Verre

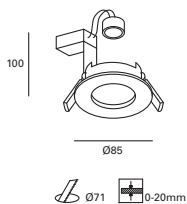

+INFO



Code	Color	Power	
DE-0129-CRO	● Chrome finish	Max. 8W (LED)	50
DE-0129-BLA	○ White	Max. 8W (LED)	50
DE-0129-NEG	● Black	Max. 8W (LED)	50



Ter NEW

MAT Aluminio
 Aluminium
 Aluminium

DIF Cristal
 Glass
 Verre

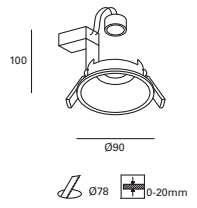

+INFO



GU10
 V/HZ 100-240V 50-60Hz
 CLASS II
 E
 IP 65

Code	Color	Power	
DE-0130-BLA	○ White	Max. 8W (LED)	50
DE-0130-NEG	● Black	Max. 8W (LED)	50



Rame NEW

MAT Aluminio
 Aluminium
 Aluminium

DIF Cristal
 Glass
 Verre

+INFO

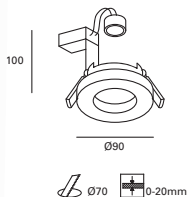

Code	Color	Power	
DE-0128-CRO	● Chrome finish	Max. 8W (LED)	50

Lab NEW

MAT Aluminio
 Aluminium
 Aluminium

DIF Cristal
 Glass
 Verre

+INFO

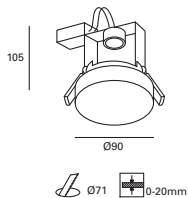

Code	Color	Power	
DE-0132-BLA	○ White finish	Max. 8W (LED)	50



Fab NEW

MAT Aluminio
 Aluminium
 Aluminium

DIF Cristal
 Glass
 Verre

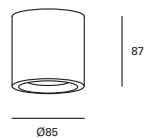

+INFO



Code	Color	Power	
DE-0131-BLA	○ White	Max. 8W (LED)	50
DE-0131-NEG	● Black	Max. 8W (LED)	50



Giro NEW

- MAT** Acero
Steel
Acier
- DIF** Cristal
Glass
Verre

+INFO



- E14
- V/HZ 100-240V 50-60Hz
- CLASS II
- IP 44

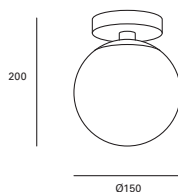

Code	Color	Power	
DE-0127-NEG	● Black	Max. 9W (LED)	8

+INFO



- PRO
- CCT
- LED
- 36,000 HOURS
- V/HZ 220-240V 50-60Hz
- LED
- INCLUDED
- CLASS II
- CRI ≥80
- IP 44

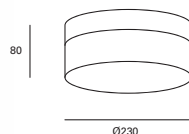

Code	Color	Power	Kelvin	Rated flux	
DE-0133-NEG	● Black	11,2W	3000K, 4000K	1487 lm*	6

* Valor basado en 4000K. Value based on 4000K. Valeur basée sur 4000K.



Petit

- MAT** Acero
Steel
Acier
- DIF** Cristal
Glass
Verre

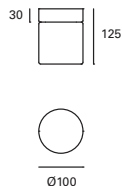

- LED**
- 36,000 HOURS
- V/HZ 100-240V 50-60Hz
- LED**
- DRIVER**
- INCLUDED**
- CLASS II**
- CRI** ≥80
- ✓
- IP 44

Code	Color	Power	Kelvin	Rated flux	
S DE-0430-CRO	● Chrome finish	7,1W	3000K	650 lm	12

Vapor

- MAT** Acero
Steel
Acier
- DIF** Cristal
Glass
Verre

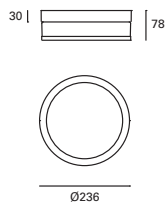

- LED**
- 36,000 HOURS
- V/HZ 100-240V 50-60Hz
- LED**
- DRIVER**
- INCLUDED**
- CLASS II**
- CRI** ≥80
- ✓
- IP 44

Code	Color	Power	Kelvin	Rated flux	
S DE-0426-CRO	● Chrome finish	13,3W	3000K	1360 lm	6



Nora NEW

- MAT** Aluminio
Aluminium
Aluminium
- DIF** Policarbonato
Polycarbonate
Polycarbonate

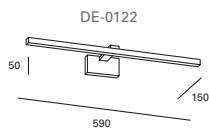
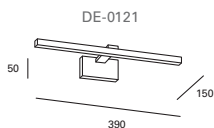

+INFO



PRO	LED	36.000 HOURS	V/HZ 220-240V 50-60Hz
DRIVER	INCLUDED	CLASS II	CRI ≥80
IP 44			

Code	Size	Color	Power	Kelvin	Rated flux	⊞
DE-0121-NEG	L390xH50mm	● Black	8,3 W	4000K	936 lm	10
DE-0122-NEG	L590xH50mm	● Black	13,5 W	4000K	1512 lm	10



Lungo

- MAT** Acero
Steel
Acier
- DIF** Policarbonato
Polycarbonate
Polycarbonate

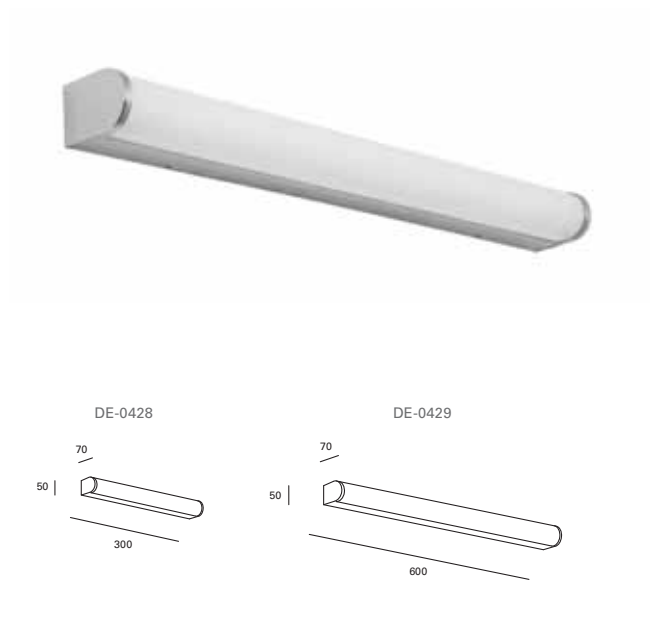

- LED**
- 36,000 HOURS
- V/HZ 100-240V 50-60Hz
- (LED)
- DRIVER
- INCLUDED
- CLASS II
- CRI ≥80
- IP 44
- IK 10

Code	Size	Color	Power	Kelvin	Rated flux	
DE-0428-CRO	L300x70mm	● Chrome finish	9,3W	3000K	910 lm	18
DE-0429-CRO	L600x70mm	● Chrome finish	13,3W	3000K	1365 lm	12



Metà NEW

MAT Aluminio
 Aluminium
 Aluminium

DIF Cristal
 Glass
 Verre

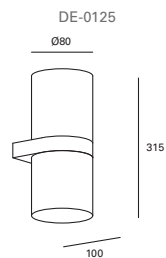
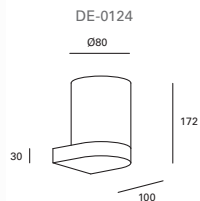

+INFO



Code	Size	Color	Power	
DE-0124-NEG	H172xD80mm	● Black	Max. 8W (LED)	12
DE-0125-NEG	H315xD80mm	● Black	2x Max. 8W (LED)	8





Ventiladores
Ceiling fans
Ventilateurs
de plafond

FANS

VE-0033-MAD



ESTUDIO Un ventilador de plafón con intensidad y temperatura de color de la luz regulable, para crear diferentes escenas según cada momento del día.

STUDIO A ceiling fan with dimmable light intensity and colour temperature to create various scenes depending on the time of day.

STUDIO Un ventilateur de plafond dont l'intensité lumineuse et la température de couleur peuvent être réglées pour créer différentes scènes en fonction du moment de la journée.

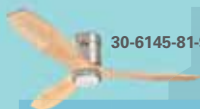
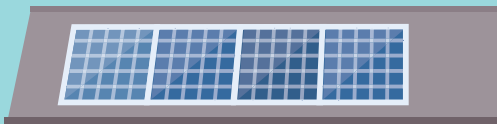

30-6145-81-93

DORMITORIO Ventilador con motor DC ultrasilencioso para garantizar un descanso óptimo y además aportar diseño al espacio.

BEDROOM Fan with ultra-quiet DC motor to guarantee optimal rest and provide a stylish design to the space.

CHAMBRE Ventilateur avec moteur DC ultra-silencieux pour garantir un repos optimal et apporter un design élégant à l'espace.

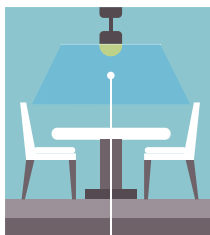
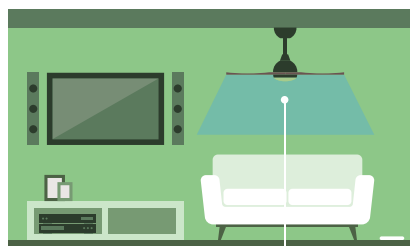
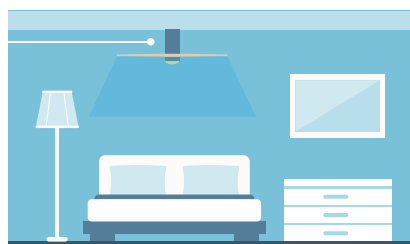

30-5378-14-F9

JARDÍN

Ventilador apto para uso exterior para unas cenas de verano agradables.

GARDEN

Fan suitable for outdoor use for pleasant summer dinners.

JARDIN

Ventilateur adapté à un usage extérieur pour d'agréables dîners d'été.

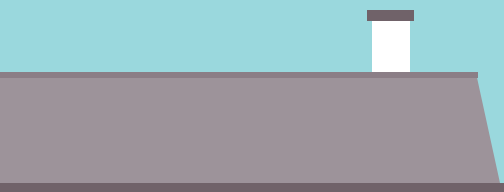

30-3249-CF-M1

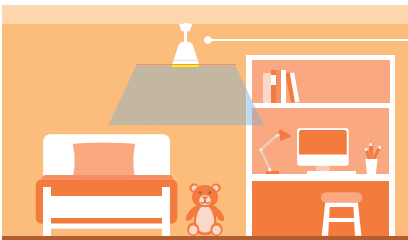

HABITACIÓN Ventilador con palas decorativas intercambiables.

Proporciona una suave brisa para un descanso placentero.

ROOM Fan with interchangeable decorative blades. Provides a light breeze for a pleasant rest.

ROOM Ventilateur avec pales décoratives interchangeables. Fournit une brise légère pour un repos agréable.



VE-0028-NEG

COCINA Un ventilador de plafón adecuado para espacios pequeños con flujo de aire concentrado y aporte lumínico adecuado para un ambiente de cocina.

KITCHEN A ceiling fan suitable for small spaces with concentrated airflow and light supply suitable for a kitchen environment.

CUISINE Un ventilateur de plafond adapté aux petits espaces avec un flux d'air concentré et un apport de lumière convenant à un environnement de cuisine.

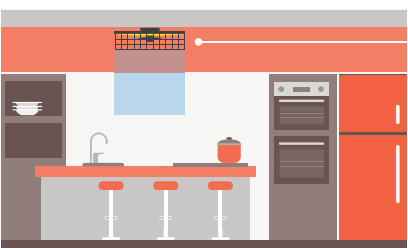

VE-0013-NEG

COMEDOR Ventiladores con función invierno verano para mejorar el rendimiento de la calefacción y contribuir al ahorro energético.

DINING ROOM Fans with winter-summer function to improve heating and heating efficiency and contribute to energy savings.

SALLE À MANGER Ventilateurs avec fonction hiver-été pour améliorer le chauffage et l'efficacité du chauffage et contribuer à contribuer aux économies d'énergie.

Warranty

10 Años
Years
Années

Garantía del motor
 Engine guaranteed
 Garantie moteur

DC Motor



Más del 50% de ahorro energético
 Over 50% energy saving
 Plus de 50% d'économie d'énergie



Mayor vida útil
 Longer working life
 Durée de vie utile allongée



Mayor control de la velocidad
 Higher speed control
 Meilleur contrôle de vitesse



Más silencioso
 More silent
 Plus silencieux



Mayor rapidez en los cambios
 Quicker changes
 Plus rapide dans les changements



Menor peso
 Lighter weight
 Moins lourd

Cómo elegir su ventilador

How to choose your fan

Comment choisir votre ventilateur

Light



Con luz
With light
Lumière incl.

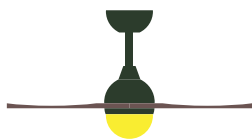

Sin luz
Without light
Lumière non incl.



Size

m²



S	< 15 m ²	< 1000 mm
M	15 m ² - 20 m ²	>1000 mm < 1320 mm
L	20 m ² - 30 m ²	> 1320 mm < 2000 mm
XL	> 30 m ²	> 2000 mm

Plafond

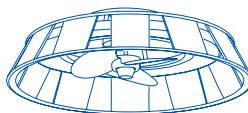

Ventilador con fuente de luz de gran eficiencia.
Pudiendo seleccionar tono de luz e intensidad.

Fan with highly efficient light source. You can select the light tone and intensity.

Ventilateur avec source lumineuse très efficace.
Vous pouvez sélectionner la tonalité et l'intensité de la lumière.

Advices

Altura
Height
Hauteur

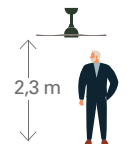

Instalación
Installation
Installation

Fije correctamente el soporte y las palas.
Utilice los contrapesos en caso de balanceo.
Finalmente tenga en cuenta que es necesario un período de 24h de asentamiento.

Fix the support and the blades correctly.
If it is unstable, please use the counterweights.
It requires 24h settling period.

Fixez correctement le support et les pales.
Utilisez les contrepois en cas de balancement.
Enfin, gardez à l'esprit qu'une période de tassement de 24 heures est nécessaire.



Instalación en techos con pendiente máxima de 15°

To be installed on ceilings with 15° maximum inclination

Installation sur plafonds à inclinaison maximale de 15°

Mim NEW

Wood



- MAT** Acero + cuerda natural
Steel + natural rope
Acier + corde naturelle
- DIF** ABS
ABS
ABS
- BLA
MAT** ABS
ABS
ABS



200



Ø610

+INFO



- TUNABLE WHITE
- LED
- AIRFLOW 3400 CFM
- MOTOR DC
- 6
- Smart home
- VOLUME
- V/Hz 220-240V 50-60Hz
- INCLUDED
- CLASS I
- V
- IP 44

	1	2	3	4	5	6
RPM	612	704	812	910	1012	1118
W	4	4,8	5,7	6,5	8,2	10

Code	Color	Power	Kelvin	Rated flux	
VE-0033-MAD	● Wood	40.2W Power motor 10W + 30.2W(LED)	2700K - 6000K	4370 lm*	1

* Valor basado en 4000K. Value based on 4000K. Valeur basée sur 4000K.



Bambu NEW

Wood



MAT Acero + madera
 Steel + wood
 Acier + bois

DIF ABS
 ABS
 ABS

**BLA
 MAT** ABS
 ABS
 ABS



+INFO

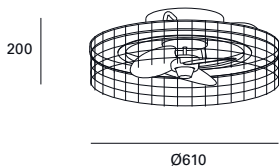

- TUNABLE WHITE
- LED
- AIRFLOW 3400 CFM
- MOTOR DC
- 6
-
-
- V/HZ 220-240V 50-60Hz
- INCLUDED
- CLASS I
- V
- IP 44

	1	2	3	4	5	6
RPM	612	704	812	910	1012	1118
W	4	4,8	5,7	6,5	8,2	10

Code	Color	Power	Kelvin	Rated flux	
VE-0035-MAD	● Wood	40.2W Power motor 10W + 30.2W(LED)	2700K - 6000K	4370 lm*	1

* Valor basado en 4000K. Value based on 4000K. Valeur basée sur 4000K.



Cil **NEW**

Black



- MAT** Acero
Steel
Acier
- DIF** ABS
ABS
ABS
- BLA
MAT** ABS
ABS
ABS



+INFO



200



Ø570

- TUNABLE WHITE
- LED
- AIRFLOW 3400 CFM
- MOTOR DC
- 6
- Smart home
- VOLUME
- V/HZ 220-240V 50-60Hz
- INCLUDED
- CLASS I
- V
- IP 44

	1	2	3	4	5	6
RPM	612	704	812	910	1012	1118
W	4	4,8	5,7	6,5	8,2	10

Code	Color	Power	Kelvin	Rated flux	
VE-0034-NEG	● Black	40.2W Power motor 10W + 30.2W (LED)	2700K - 6000K	4370 lm*	1

* Valor basado en 4000K. Value based on 4000K. Valeur basée sur 4000K.



Merak NEW

Black



- MAT** Acero
Steel
Acier
- DIF** Acrílico
Acrylic
Acrylique
- BLA
MAT** ABS
ABS
ABS

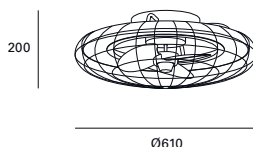

+INFO



- TUNABLE WHITE
- LED
- AIRFLOW 3400 CFM
- MOTOR DC
- 6
-
- V/HZ 220-240V 50-60Hz
- INCLUDED
- CLASS I
- V
- IP 44

	1	2	3	4	5	6
RPM	612	704	812	910	1012	1118
W	4	4,8	5,7	6,5	8,2	10

Code	Color	Power	Kelvin	Rated flux	
VE-0028-NEG	● Black	40.2W Power motor 10W + 30.2W (LED)	2700K - 6000K	4370 lm*	1

* Valor basado en 4000K. Value based on 4000K. Valeur basée sur 4000K.



Zonda NEW

Transparent



- MAT** Acero
Steel
Acier
- DIF** Policarbonato
Polycarbonate
Polycarbonate
- BLA
MAT** Policarbonato
Polycarbonate
Polycarbonate

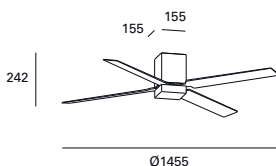

+INFO



- LED
- AIRFLOW
6597
CFM
- MOTOR
DC
- 5
-
-
-
- V/HZ
220-240V
50-60Hz
- INCLUDED
- CLASS I
-

30-8549-14-M1

- CCT
- SMART

	1	2	3	4	5
RPM	98	118	135	145	178
W	7,5	10	14	19	31

Code	Color	Power	Kelvin	Rated flux	
30-8548-14-M1	○ White	53.3W Power motor 31W + 22.3W(LED)	3000K	1900 lm	1
30-8549-14-M1	○ White	50W Power motor 31W + 19W (LED)	3000K, 4000K, 5700K	1900 lm*	1

* Valor basado en 4000K. Value based on 4000K. Valeur basée sur 4000K.



Bosc

Wood



- MAT Acero
Steel
Acier
- DIF Opal
Opal
Opale
- BLA
MAT Madera
Wood
Bois

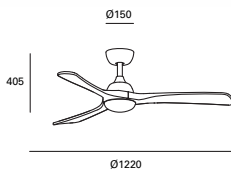

+INFO



- CCT
- LED
- AIRFLOW
4500 CFM
- MOTOR
DC
- 5
-
- V/HZ
220-240V
50-60Hz
- INCLUDED
- CLASS I
-

	1	2	3	4	5
RPM	81	113	130	160	200
W	5	7	9,7	15	27

Code	Color	Power	Kelvin	Rated flux	
VE-0013-NEG	● Black	48W Power motor 27W + 21W (LED)	2800K, 4000K,	870 lm*	1
			5700K		

* Valor basado en 4000K. Value based on 4000K. Valeur basée sur 4000K.



Shadow

Brown



MAT Acero
 Steel
 Acier

**BLA
 MAT** ABS
 ABS
 ABS

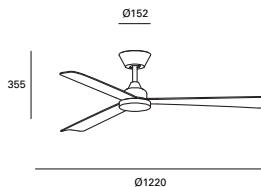

+INFO



- AIRFLOW 4300 CFM
- MOTOR DC
- 5
-
- V/HZ 220-240V 50-60Hz
- CLASS I
-

	1	2	3	4	5
RPM	115	146	171	193	213
W	6	11	17	24	34

Code	Color	Power	
VE-0015-MAR	● Brown	34W	1



Stem

- MAT** Acero
Steel
Acier
- DIF** Cristal
Glass
Verre
- BLA
MAT** Madera
Wood
Bois

Dark wood 30-8140-81-92
 Clear wood 30-8644-81-93



+INFO



- CCT
-
- LED
- MOTOR DC
- 5
-
-
-
- V/HZ
220-240V
50-60Hz
- INCLUDED
- CLASS I
-

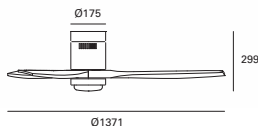

30-8140

- SMART
- TUNABLE WHITE
- AIRFLOW
6162 CFM

30-8644

- AIRFLOW
5000 CFM

	1	2	3	4	5
RPM	75	115	150	175	200
W	3	7	15	23	36

Code	Color	Power	Kelvin	Rated flux	
30-8140-81-92	● Satin nickel	49W Power motor 63W + 13W(LED)	3000K - 5700K	1870 lm*	1
30-8644-81-92	● Satin nickel	85,5W Power motor 33,5W + 52W(LED)	3000K, 4000K, 5000K	2589 lm*	1
30-8644-81-93	● Satin nickel	51,3W Power motor 33,5 + 17,8W (LED)	3000K, 4000K, 5000K	1870 lm*	1

* Valor basado en 4000K. Value based on 4000K. Valeur basée sur 4000K.



Stem

- MAT** Acero
Steel
Acier
- DIF** Cristal
Glass
Verre
- BLA
MAT** Madera
Wood
Bois

Dark wood 30-8645-81-92 Clear wood 30-8645-81-93

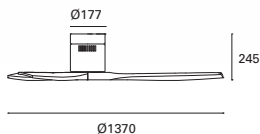

	AIREFLOW 5000 CFM	MOTOR DC	 5
			V/HZ 220-240V 50-60Hz

	1	2	3	4	5
RPM	75	115	150	175	200
W	3	7	15	23	36

Code	Color	Power	Kelvin	
30-8645-81-92	● Satin nickel	33,5W	3000K	1
30-8645-81-93	● Satin nickel	33,5W	3000K	1



Klar

- MAT** Acero
Steel
Acier
- DIF** Cristal
Glass
Verre
- BLA
MAT** DM
DM
DM

Clear wood or white
30-4864-16-F9



Clear wood or brown
30-4864-J7-F9

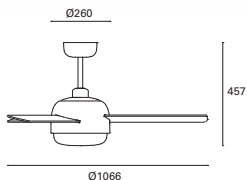

- E27
- AIRFLOW
2902
CFM
- 3
-
-
- VHZ
220-240V
50-60Hz
- CLASS I
-

	1	2	3
RPM	100	145	195
W	11	23	42

Code	Color	Power	
30-4864-16-F9	○ White	72W Power motor 42W + 2x Max. 15W (LED)*	1
30-4864-J7-F9	● Brown	72W Power motor 42W + 2x Max. 15W (LED)*	1

* L=140mm / Ø45mm



Windy

- MAT** Acero
Steel
Acier
- DIF** Cristal
Glass
Verre
- BLA
MAT** Madera
Wood
Bois

Wood or white



VE-0004

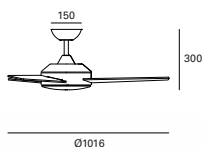

+INFO



VE-0005-BLA

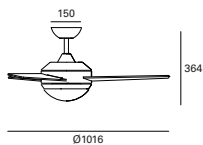

VE-0004



VE-0005



	1	2	3
RPM	85	145	225
W	6	16	43

Code	Color	Power	
VE-0004-BLA	○ White	43W	1
VE-0005-BLA	○ White	73W power motor 43W + 2x Max. 15W (LED)	1



Phuket

MAT Acero
 Steel
 Acier

**BLA
 MAT** ABS
 ABS
 ABS

Dark brown
 30-4398-J7-J7



Clear brown
 30-4398-16-16

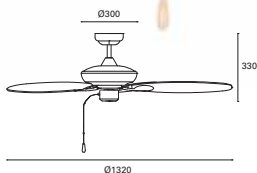

Simil ratán



AIRFLOW
 5020
 CFM

3



VHZ
 220-240V
 50-60Hz



CLASS I



Code	Color	Power	☒
------	-------	-------	---

30-4398-J7-J7	● Brown	56W	1
---------------	---------	-----	---

30-4398-16-16	○ White	56W	1
---------------	---------	-----	---

Code	Description	Power
------	-------------	-------

71-4398-16-F9	Optional light kit	2x Max. 15W (LED)
---------------	--------------------	-------------------

71-4398-J7-F9	Optional light kit	2x Max. 15W (LED)
---------------	--------------------	-------------------

71-4398-16-F9 71-4398-J7-F9



	1	2	3
RPM	80	120	175
W	14	28	56



Xaloc

- MAT** Acero
Steel
Acier
- BLA
MAT** Madera
Wood
Bois



★
 Embellecedor incluido.
 Trim included.
 Garniture incluse.



30-8340 / 30-8342

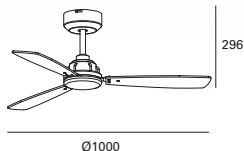

- AIRFLOW 4200 CFM
- MOTOR DC
- 5
-
-
- V/HZ 110-240V 50-60Hz
- CLASS I
-

30-8342



	1	2	3	4	5
RPM	175	210	230	250	290
W	6	8	9,8	11,7	17,4

Code	Color	Power	☒
30-8340-05-05	● Black wood	17,4W	1
30-8340-05-43	● Dark wood	17,4W	1
30-8340-05-93	● Clear wood	17,4W	1
30-8342-05-05	● Black wood	17,4W	1
30-8342-05-43	● Dark wood	17,4W	1
30-8342-05-93	● Clear wood	17,4W	1

Code	Description
71-8345-05-05	500mm bar accessory

71-8345

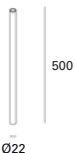

Black wood



Dark wood



Clear wood



30-8341 / 30-8343

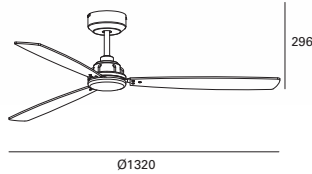

- AIRFLOW**
5000 CFM
- MOTOR DC**
5
- V/HZ**
110-240V
50-60Hz
- CLASS I**

30-8343



	1	2	3	4	5
RPM	118	146	178	193	216
W	7,4	12	19	23,1	33,5

Code	Color	Power	
30-8341-05-05	● Black wood	33,5W	1
30-8341-05-43	● Dark wood	33,5W	1
30-8341-05-93	● Clear wood	33,5W	1
30-8343-05-05	● Black wood	33,5W	1
30-8343-05-43	● Dark wood	33,5W	1
30-8343-05-93	● Clear wood	33,5W	1

Code	Description
71-8345-05-05	500mm bar accessory

71-8345



Ø22

Embat

Wood



- MAT** Acero
Steel
Acier
- DIF** Cristal
Glass
Verre
- BLA
MAT** Madera
Wood
Bois

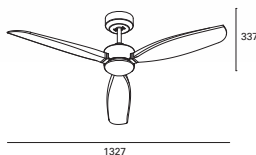

- LED
- AIRFLOW
4500
CFM
- MOTOR
DC
- 5
-
-
-
- V/HZ
220-240V
50-60Hz
- INCLUDED
- CLASS I
-

	1	2	3	4	5
RPM	100	126	162	177	200
W	7	11	18	24	33

Code	Color	Power	Kelvin	Rated flux	
30-8000-81-F9	● Satin nickel	52.8W motor power 33W + 19.8W(LED)	3000K	627 lm	1



Mariner

Black Grey



- MAT** Acero
Steel
Acier
- DIF** Cristal
Glass
Verre
- BLA
MAT** Acero
Steel
Acier

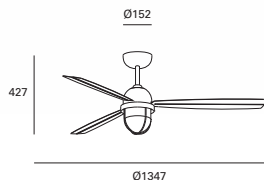

-
- E27
- AIRFLOW
4500
CFM
- MOTOR
DC
- 5
-
-
-
- V/HZ
110-240V
50-60Hz
- CLASS I
-

	1	2	3	4	5
RPM	100	138	165	180	200
W	7,1	11	17,3	23	32,7

Code	Color	Power	
30-8550-81-37	● Satin nickel	47.7W Power motor 32.7W + Max. 15W (LED)	1
30-8550-05-37	● Black	47.7W Power motor 32.7W + Max. 15W (LED)	1



Formentera

- MAT** Aluminio
Aluminium
Aluminium
- DIF** Acero
Steel
Acier
- BLA
MAT** Policarbonato
Polycarbonate
Polycarbonate

Grey or white
30-4393-N3-M1



White or grey
30-4393-CF-M1

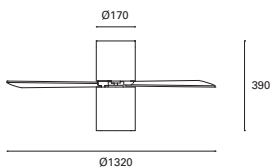

-
- E27
- AIRFLOW
5491
CFM
- 3
-
-
-
- VHZ
220-240V
50-60Hz
-
-

	1	2	3
RPM	100	150	200
W	19	36	66

Code	Color	Power	
30-4393-N3-M1	● Grey	81W Power motor 66W + Max. 15W (LED)*	1
30-4393-CF-M1	○ White	81W Power motor 66W + Max. 15W (LED)*	1

Code	Description
71-4393-CF-CF	White light kit accessory
71-4393-N3-N3	Grey light kit accessory

71-4393



* L=140mm / Ø56mm



Pam

White



- MAT** Acero
Steel
Acier
- DIF** Acrílico
Acrylic
Acrylique
- BLA
MAT** Policarbonato
Polycarbonate
Polycarbonate

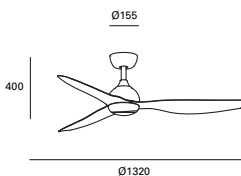

+INFO



- CCT
- LED
- AIRFLOW
5000 CFM
- MOTOR
DC
- 5
-
-
- V/HZ
220-240V
50-60Hz
- INCLUDED
- CLASS I
-

	1	2	3	4	5
RPM	87	107	127	168	204
W	6,8	6	12	19	35

Code	Color	Power	Kelvin	Rated flux	
VE-0014-BLA	○ White	56W power motor 35W + 21W(LED)	2800K, 4000K,	870 lm*	1
			5700K		

* Valor basado en 4000K. Value based on 4000K. Valeur basée sur 4000K.



Buran

White or wood



- MAT** Aluminio + Acero
Aluminium + Steel
Aluminium + Acier
- DIF** Cristal
Glass
Verre
- BLA
MAT** Madera
Wood
Bois

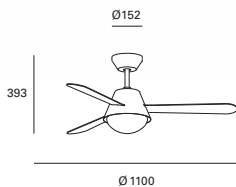

-
- E27
- AIRFLOW
4030
CFM
- MOTOR
DC
- 5
-
-
-
-
- V/HZ
110-240V
50-60Hz
- CLASS I
-

	1	2	3	4	5
RPM	64	140	174	206	235
W	6	8,5	12	17	26,7

Code	Color	Power	
30-8551-14-F9	○ White	56.7W Power motor 26.7W + 2x Max.15W (LED)	1



Inca

- MAT Acero
Steel
Acier
- DIF Cristal
Glass
Verre
- BLA
MAT Madera
Wood
Bois

Clear wood or white

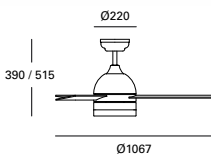

	LED	AIRFLOW 4000 CFM	3
		VHZ 220-240V 50-60Hz	
INCLUDED	CLASS I	√	

	1	2	3
RPM	167	210	220
W	25	41	49

	Code	Color	Power	Kelvin	Rated flux	
S	VE-0001-BLA	○ White	6825W Power motor 49W + 19,5W (LED)	3000K	1530 lm	1



Kai

White



- MAT** Acero
Steel
Acier
- DIF** Cristal
Glass
Verre
- BLA
MAT** Madera
Wood
Bois

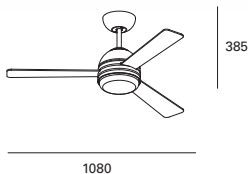

	E14	AIRFLOW 4800 CFM	MOTOR DC
5			
V/HZ 110-240V 50-60Hz	CLASS I		

	1	2	3	4	5
RPM	154	170	194	214	248
W	3,6	5,5	7,3	9,2	15

Code	Color	Power	
30-7999-14-F9	○ White	33W Power motor 15W + 2x Max. 9W (LED)	¹



Bora

White



- MAT** Acero
Steel
Acier
- DIF** Cristal
Glass
Verre
- BLA
MAT** PC
PC
PC



30-7972

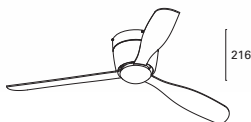

1238

30-7973



988

- LED
- MOTOR DC
- 5
-
-
-
- V/HZ
220-240V
50-60Hz
- INCLUDED
- CLASS I
-

30-7972

AIRFLOW
5300
CFM

	1	2	3	4	5
RPM	118	134	148	170	195
W	7,3	10,2	13,9	24,4	33,3

30-7973

AIRFLOW
4100
CFM

	1	2	3	4	5
RPM	160	175	190	215	240
W	7,3	9,2	11,2	15,3	20,1

Code	Color	Power	Kelvin	Rated flux	
30-7972-14-F9	○ White	51,7W Power motor 33,7W + 18W (LED)	3000K	1800 lm	1
30-7973-14-F9	○ White	38,1W Power motor 20,1W + 18W (LED)	3000K	1800 lm	1



Tupai

- MAT** Acero
Steel
Acier
- BLA
MAT** Madera
Wood
Bois

White or clear grey
 30-4863-CF-CF / 30-4866-CF-CF

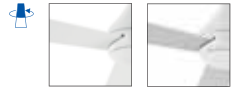

Clear grey or grey
 30-4863-81-81 / 30-4866-81-81



-
- AIRFLOW**
5775 CFM
- MOTOR DC**
-
-
-
-
- V/HZ**
110-240V
50-60Hz
- CLASS I**
-

30-4863

	1	2	3	4	5
RPM	106	159	209	263	306
W	4	6	12	23	36

30-4866

	1	2	3	4	5
RPM	74	112	155	190	218
W	3	6	13	22	35

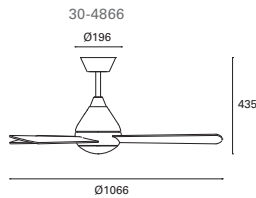
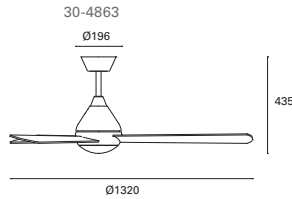

Code	Color	Power	
30-4863-CF-CF	○ White	35W	1
30-4863-81-81	● Satin nickel	35W	1
30-4866-CF-CF	○ White	35W	1
30-4866-81-81	● Satin nickel	35W	1



Nepal

White



- MAT** Acero
Steel
Acier
- DIF** Cristal
Glass
Verre
- BLA
MAT** ABS
ABS
ABS

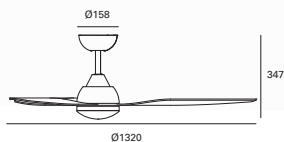
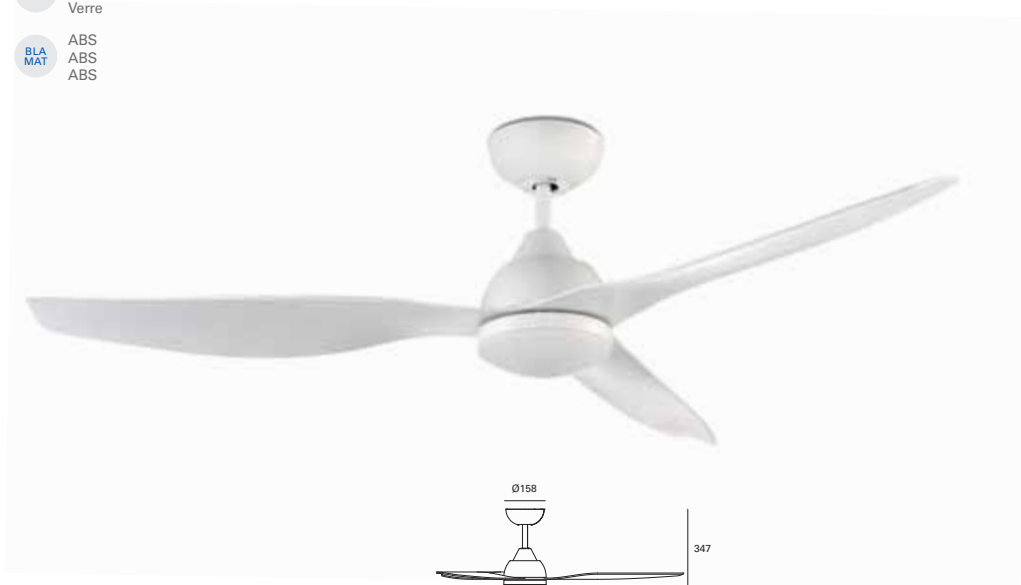

- LED**
- AIRFLOW**
7067 CFM
- 50,000 HOURS**
- MOTOR DC**
- 5**
-
-
- V/HZ**
220-240V
50-60Hz
- INCLUDED**
- CLASS I**
-

30-8141

- TUNABLE WHITE**
- SMART**

	1	2	3	4	5
RPM	131	142	170	187	200
W	8	11	18	24	33

Code	Color	Power	K	lm	
30-7644-CF-F9	○ White	47,5W Power motor 33W + 14,5W (LED)	3000K	950 lm	1
30-8141-CF-F9	○ White	51,7W Power motor 33W + 18,7W (LED)	3000K - 5700K	927 lm*	1

* Valor basado en 4000K. Value based on 4000K. Valeur basée sur 4000K.



Helix

MAT Acero
 Steel
 Acier

DIF Cristal
 Glass
 Verre

**BLA
 MAT** ABS
 ABS
 ABS

White Dark wood

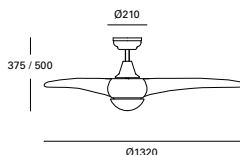

+INFO



- LED
- AIRFLOW
4500
CFM
- MOTOR
DC
- 5
-
-
-
- V/HZ
220-240V
50-60Hz
- INCLUDED
- CLASS I
-

	1	2	3	4	5
RPM	99	132	156	175	204
W	4	8	14	21	36

S

Code	Color	Power	Kelvin	Rated flux	
VE-0002-BLA	○ White	42,6W Power motor 36W + 6,6W (LED)	3000K	540 lm	1
VE-0002-MAD	● Wood	42,6W Power motor 36W + 6,6W (LED)	3000K	540 lm	1



Lodos

White



- MAT** Acero + Aluminio
Steel + Aluminium
Acier + Aluminium
- DIF** Cristal
Glass
Verre
- BLA
MAT** Madera
Wood
Bois

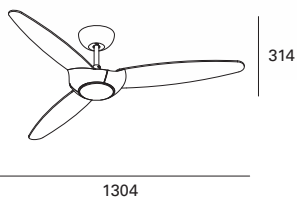

	LED	AIRFLOW 4800 CFM	MOTOR DC
V/Hz 220-240V 50-60Hz	INCLUDED	CLASS I	

	1	2	3	4	5
RPM	130	170	200	220	240
W	7	11	18	24	33

Code	Color	Power	Kelvin	Rated flux	
30-7740-14-F9	○ White	47,7W Power motor 47,7W + 14,7W (LED)	2700K	2520 lm	1



Tramuntana

Transparent



- MAT Acero
Steel
Acier
- DIF Cristal
Glass
Verre
- BLA
MAT Acrílico
Acrylic
Acrylique

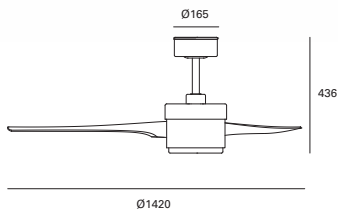

- LED
- AIRFLOW
4000 CFM
- MOTOR
DC
- 5
-
-
-
- V/HZ
100-240V
50-60Hz
- INCLUDED
- CLASS I
-
- IP 44

	1	2	3	4	5
RPM	95	120	144	165	200
W	8,5	13,4	21,1	31,8	50,2

Code	Color	Power	Kelvin	Rated flux	
30-7643-14-F9	○ White	72W Power motor 50,2W + 21,8W (LED)	3000K	1020 lm	1



Garbí

Transparent



- MAT Acero
Steel
Acier
- DIF Cristal
Glass
Verre
- BLA
MAT Acrílico
Acrylic
Acrylique

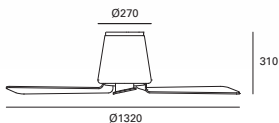

- LED
- AIRFLOW
6173
CFM
- MOTOR
DC
- 5
-
-
-
- V/HZ
110-240V
50-60Hz
- INCLUDED
- CLASS I
-
- IP 44

	1	2	3	4	5
RPM	110	138	165	193	221
W	4,1	5,8	11,2	18,5	30

Code	Color	Power	Kelvin	Rated flux	
30-5378-14-F9	○ White	45W Power motor 45W + 15W (LED)	3000K	1400 lm	1



Tiga

- MAT** Acero y Aluminio
Steel and Aluminium
Acier et Aluminium
- DIF** Cristal
Glass
Verre
- BLA MAT** Acrílico
Acrylic
Acrylique

Transparent

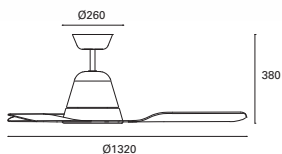

- LED**
- AIRFLOW**
5161 CFM
- 3**
- S**
- V/HZ**
220-240V
50-60Hz
- INCLUDED**
- CLASS I**
-

	1	2	3
RPM	80	145	195
W	9	28	58

Code	Color	Power	Kelvin	Rated flux	
30-3249-CF-M1	White	76W Power motor 58W + 18W(LED)	3000K	1800 lm	1

Code	Description
71-1843-CF-CF	300mm white bar accessory compatible with AC motors
71-1844-CF-CF	460mm white bar accessory compatible with AC motors
71-4867-24-24	Shovels of yellow-green color
71-4867-11-11	Cyan shovels
71-4867-13-13	Magenta shovels

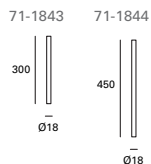



Gregal

Transparent



- MAT Acero
Steel
Acier
- DIF Cristal
Glass
Verre
- BLA
MAT Acrílico
Acrylic
Acrylique

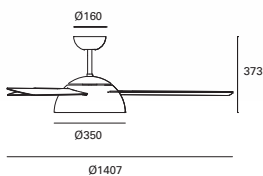

	LED	AIRFLOW 6102 CFM	MOTOR DC
V/HZ 120-240V 50-60Hz	INCLUDED	CLASS I	

	1	2	3	4	5
RPM	92	132	162	196	220
W	6	10	15	24	35

	Code	Color	Power	Kelvin	Rated flux	
S	30-6489-60-F9	○ Black	64W Power motor 35W + 29W (LED)	3000K	4010 lm	1



Sirocco

Transparent



- MAT** Acero
Steel
Acier
- DIF** Cristal
Glass
Verre
- BLA
MAT** Policarbonato
Polycarbonate
Polycarbonate

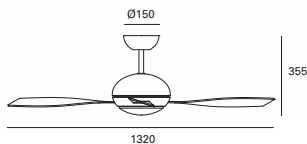

- LED
- AIRFLOW
3800
CFM
- MOTOR
DC
- 5
-
-
-
- V/Hz
220-240V
50-60Hz
- INCLUDED
- CLASS I
- V

	1	2	3	4	5
RPM	115	145	172	202	235
W	7,5	12,4	20,3	31,2	50

	Code	Color	Power	Kelvin	Rated flux	
S	30-7657-81-EC	● Satin nickel	66W Power motor 50W + 16W (LED)	3000K	1027 lm	1



Mogan

White



MAT Aluminio
 Aluminium
 Aluminium

**BLA
 MAT** Acero
 Steel
 Acier



Verano.
 Summer.
 Été.

Invierno.
 Winter.
 l'Hiver.

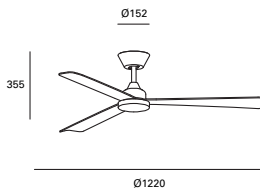

-
- AIRFLOW**
6038
CFM
-
-
-
-
- V/HZ**
230V
50-60Hz
-
-

Code **Color** **Power**

30-4356-CF-CF ○ White 65W 1

Code	Description
71-1843-CF-CF	300mm white bar accessory compatible with AC motors
71-1844-CF-CF	450mm white bar accessory compatible with AC motors

71-1843



71-1844

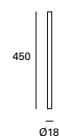

	1	2	3
RPM	140	200	230
W	20	35	50



Lace

MAT Acero
 Steel
 Acier

**BLA
 MAT** Acero
 Steel
 Acier





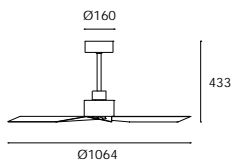



White

Grey



+INFO



-  **AIRFLOW**
5491
CFM
-  **MOTOR**
DC
-  5
-   
-  **VHZ**
100-240V
50-60Hz
-  **CLASS I**
- 

	1	2	3	4	5
RPM	136	180	206	236	266
W	3,8	6,5	9,2	13,5	22,6

Code	Color	Power	
VE-0007-BLA	○ White	22,6W	1
VE-0007-GRI	● Grey	22,6W	1

Handia

Grey



MAT Acero
Steel
Acier

**BLA
MAT** Aluminio
Aluminium
Aluminium

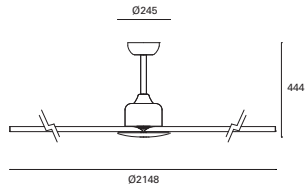

	AIRFLOW 14500 CFM	MOTOR DC	 6
		V/HZ 220-240V 50-60Hz	 CLASS 1
	↓		

	1	2	3	4	5	6
RPM	30	41	52	63	74	88
W	4	7	9	11	20	35

Code	Color	Power	
30-5638-DB-DB	● Grey	35W	1

Calima

White Grey Beige



- MAT** Acero
Steel
Acier
- DIF** Cristal
Glass
Verre
- BLA
MAT** Textil + ABS
Textile + ABS
Textile + ABS

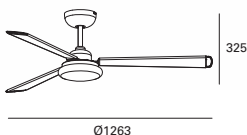

- LED
- 50,000 HOURS
- AIRFLOW 3800 CFM
- MOTOR DC
- INCL
- CLASS I
- V/HZ 220-240V 50-60Hz
- INCLUDED
- CLASS I
- ✓

30-8407-81-14

- TUNABLE WHITE
- SMART
- 6

	1	2	3	4	5	6
RPM	114	144	180	210	220	235
W	7,2	11,8	18,6	23,1	26,7	33,5

30-8408-81-14

- 5

	1	2	3	4	5
RPM	131	168	200	216	241
W	7,2	11,8	18,6	23,1	33,5

Code	Color	Power	Kelvin	Rated flux	☰
30-8408-81-14	● Satin nickel	51W Power motor 33.5W + 17.5W (LED)	3000K	551 lm	1
30-8407-81-14	● Satin nickel	49.3W Power motor 33.5W + 15.8W (LED)	3000K - 5700K*	823 lm*	1

Code	Description
71-8409-34-34	Grey blades kit
71-8409-20-20	Beige blades kit

* Valor basado en 4000K. Value based on 4000K. Valeur basée sur 4000K.



Borneo

- MAT Acero
Steel
Acier
- DIF Cristal
Glass
Verre
- BLA
MAT Madera
Wood
Bois

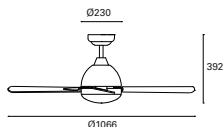
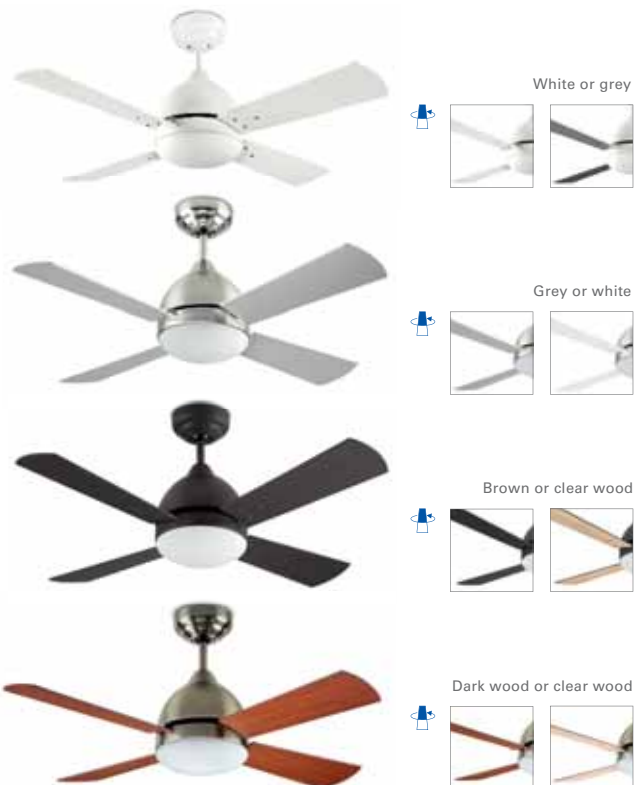

+INFO



- E27
- AIRFLOW
4300
CFM
- 3
- V/HZ
230V
50-60Hz
- CLASS I
-

	1	2	3
RPM	100	145	185
W	12	21	40

S

Code	Color	Power	
VE-0006-BLA	○ White	70W Power motor 40W + 2x Max. 15W (LED)	1
VE-0006-SAT	● Satin nickel	70W Power motor 40W + 2x Max. 15W (LED)	1
VE-0006-MAR	● Brown	70W Power motor 40W + 2x Max. 15W (LED)	1
VE-0006-PAT	● Antique brass	70W Power motor 40W + 2x Max. 15W (LED)	1



Kudari

White or wood



- MAT** Acero
Steel
Acier
- DIF** Policarbonato
Polycarbonate
Polycarbonate
- BLA
MAT** Madera
Wood
Bois

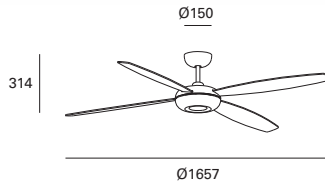

-
- AIRFLOW**
5500
CFM
- MOTOR**
DC
-
-
-
-
-
- V/HZ**
100-240V
50-60Hz
- CLASS I**
-

30-8547-14-14



	1	2	3	4	5
RPM	77	100	126	142	180
W	9,5	13,5	20,6	28	52

Code	Color	Power	
30-8546-14-14	White and wood	52W	1
30-8547-14-14	White and wood	52W	1



Rodas

White



MAT Aluminio
 Aluminium
 Aluminium

**BLA
 MAT** Madera
 Wood
 Bois

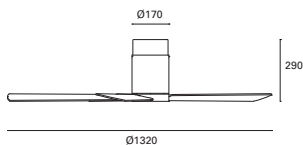

Discos de color incluidos

Color discs included.

Disques de couleur inclus.

-   AIRFLOW
5303
CFM
-  E27
-  3
-   V/HZ
230V
50-60Hz
-   CLASS I
- 

	1	2	3
RPM	90	135	180
W	16	26	53

Code	Color	Power	
30-1964-CF-CF	○ White	53W	1

Code	Description
71-1964-CF-CF	350mm bar accessory

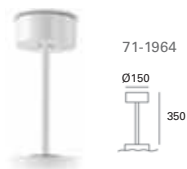



Hawaii

Dark brow or grey



- MAT** Aluminio
Aluminium
Aluminium
- DIF** Cristal
Glass
Verre
- BLA
MAT** Madera
Wood
Bois

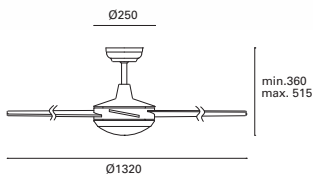

-
- R7s
- AIRFLOW**
5889
CFM
- 3
-
-
-
- V/HZ**
230V
50Hz
-
-

Code	Color	Power	Kelvin	Rated flux	
S 30-2854-81-F9	● Satin nickel	166W Power motor 6W + Max. 100W (LED)	3000K	1020 lm	1

Code	Description	71-1843	71-1844
71-1843-CF-CF	300mm white bar accessory compatible with AC motors		
71-1844-CF-CF	450mm white bar accessory compatible with AC motors		

	1	2	3
RPM	130	180	220
W	22	39	66



Samal

White or grey



- MAT** Acero
Steel
Acier
- DIF** Cristal
Glass
Verre
- BLA
MAT** Madera
Wood
Bois

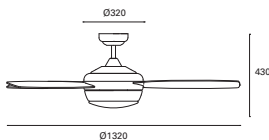

- E27
- AIRFLOW
6451
CFM
- 3
-
-
-
- V/HZ
220-240V
50-60Hz
- CLASS I
-

	1	2	3
RPM	94	147	220
W	12	27	72

Code	Color	Power	
S 30-0068-14-F9	○ White	102W power motor 72W + 2x Max. 15W (LED)	1

Code	Description
71-1843-CF-CF	300mm white bar accessory compatible with AC motors
71-1844-CF-CF	450mm white bar accessory compatible with AC motors

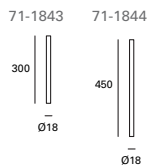

Accessory

Bars



Code	Description	
71-1843-81-81	300mm	10
71-1843-CF-CF	300mm	10
71-1844-81-81	450mm	10
71-1844-CF-CF	450mm	10

* Compatible with all models, except for those with DC engine.

Wall control (3 speeds)



Code	
71-4933-00-00*	40

* Compatible with all models, except for those with DC engine.

Wall control (3 speeds and light on/off)



Code	
71-4932-00-00*	40

* Compatible with all models, except for those with DC engine.

Remote control



Code	
71-6054-00-00*	40

* Compatible with all models, except for those with DC engine.

REFERENCE	PAGE	EAN13	REFERENCE	PAGE	EAN13	REFERENCE	PAGE	EAN13
30-0068-14-F9	506	8435111089873	DE-0014-NEG	348	8445386076553	PX-0024-OXI	294	8435111055250
30-1964-CF-CF	502	8435381402440	DE-0015-BLA	348	8445386076560	PX-0025-OXI	294	8435111055274
30-2854-81-F9	504	8435111070659	DE-0015-NEG	348	8445386076577	PX-0026-OXI	257	8435111055267
30-3249-CF-M1	486	8435381412524	DE-0016-BLA	348	8445386076584	PX-0026-OXI	294	8435111055267
30-4356-CF-CF	492	8435381401771	DE-0016-NEG	348	8445386076591	PX-0027-OXI	295	8435111055281
30-4393-CF-M1	462	8435381401740	DE-0020-BLA	386	8443562976285	PX-0027-OXI	261	8435111055281
30-4393-N3-M1	462	8435111082829	DE-0020-GRI	386	8445386083209	PX-0028-OXI	229	8435111074800
30-4398-16-16	454	8435381454111	DE-0022-NEG	326	8445386074740	PX-0029-MAR	257	8435111054925
30-4398-J7-J7	454	8435111082614	DE-0023-NEG	314	8435629748606	PX-0033-ANT	259, 296	8435111082492
30-4863-81-81	474	8435381425388	DE-0024-NEG	314	8435629748613	PX-0034-ANT	233, 296	8435111082393
30-4863-CF-CF	474	8435381425371	DE-0114-BLA	368	8445386487625	PX-0047-GRI	144	8435381430085
30-4864-16-F9	450	8435381423001	DE-0115-BLA	364	8445386485829	PX-0056-GRI	200	8435381454234
30-4864-J7-F9	450	8435381454128	DE-0115-NEG	364	8445386485836	PX-0056-NEG	200	8435381454237
30-4866-81-81	474	8435381425364	DE-0116-BLA	350	8445386485850	PX-0086-ANT	256	8435381436636
30-4866-CF-CF	474	8435381425357	DE-0116-NEG	350	8445386485867	PX-0087-ANT	256	8435381436643
30-5378-14-F9	484	8435381440190	DE-0117-BLA	354	8445386487588	PX-0096-ANT	266	8435381438388
30-5638-DB-DB	495	8435381454388	DE-0117-NEG	354	8445386487595	PX-0098-INO	233, 291	8435381454166
30-6489-60-F9	488	8435381439855	DE-0118-BLA	360	8445386485799	PX-0099-ANT	254, 290	8435381438470
30-7643-14-F9	482	8435526867608	DE-0118-NEG	360	8445386485805	PX-0099-INO	254, 290	8435381454623
30-7644-CF-F9	476	8435526867868	DE-0121-NEG	420	8445386487366	PX-0100-ANT	254, 290	8435381438487
30-7657-81-EC	490	8435526870035	DE-0122-NEG	420	8445386487373	PX-0100-INO	254, 290	8435381454630
30-7740-14-F9	480	8435557324084	DE-0123-BLA	366	8445386487656	PX-0102-ANT	250, 286	8435575399129
30-7972-14-F9	472	8435575324053	DE-0124-NEG	424	8445386487465	PX-0103-ANT	250, 286	8435575399136
30-7973-14-F9	472	8435575324060	DE-0125-NEG	424	8445386487472	PX-0111-NEG	126	8435381438555
30-7999-14-F9	470	8435575324046	DE-0127-NEG	416	8445386627502	PX-0122-INO	142	8435381439829
30-8000-81-F9	458	8435575324077	DE-0128-CRO	67, 412	8445386487228	PX-0123-INO	110	8435381444064
30-8140-81-92	446	8435575324091	DE-0129-BLA	65, 408	8445386487243	PX-0126-NEG	152	8435381440206
30-8141-CF-F9	476	8435575324107	DE-0129-CRO	65, 408	8445386487236	PX-0127-NEG	200	8435381448752
30-8340-05-05	456	84453860898478	DE-0129-NEG	65, 408	8445386487250	PX-0128-INO	110	8435381440817
30-8340-05-43	456	84453860898485	DE-0130-BLA	66, 410	8445386487267	PX-0129-NEG	154	8435381440924
30-8340-05-93	456	84453860898492	DE-0130-NEG	66, 410	8445386487274	PX-0130-NEG	152	8435381449254
30-8341-05-05	457	84453860898508	DE-0131-BLA	74, 414	3276007499117	PX-0133-NEG	222, 292	8435575398661
30-8341-05-43	457	84453860898515	DE-0131-NEG	74, 414	3276007499124	PX-0134-NEG	255, 292	8435575399709
30-8341-05-93	457	84453860898522	DE-0132-BLA	67, 412	8445386487286	PX-0135-NEG	220	8435575399433
30-8342-05-05	456	84453860898539	DE-0133-NEG	416	8445386632950	PX-0139-NEG	125	8435381449829
30-8342-05-43	456	84453860898546	DE-0134-NEG	380, 400	8445386487496	PX-0140-NEG	198	8435629762480
30-8342-05-93	456	84453860898553	DE-0135-NEG	394, 401	8445386487489	PX-0144-NEG	126	8435381449544
30-8343-05-05	457	84453860898560	DE-0136-NEG	376, 400	8445386487503	PX-0147-NEG	223	8435575399471
30-8343-05-43	457	84453860898577	DE-0180-BLA	328	8435381449193	PX-0148-ANT	168	8445386081854
30-8343-05-93	457	84453860898584	DE-0180-NEG	328	8435381449209	PX-0149-GRI	172	8435575399853
30-8407-81-14	496	8445386082028	DE-0198-BLA	338	8435381449513	PX-0150-GRI	118	8435575399860
30-8408-81-14	496	8445386082035	DE-0199-BLA	340	8435381449520	PX-0152-ANT	130	8435629748637
30-8546-14-14	500	8445386132501	DE-0225-MAR	346	8435381452643	PX-0153-ANT	130	8435629748644
30-8547-14-14	500	8445386132518	DE-0226-MAR	346	8435381452650	PX-0158-ANT	106	8435629762688
30-8548-14-M1	440	8445386132969	DE-0227-MAR	346	8435381452667	PX-0159-NEG	270	8445386075075
30-8549-14-M1	440	8445386132976	DE-0229-BLA	370	8435381452735	PX-0161-CEM	258, 298	8445386074856
30-8550-05-37	460	8445386132464	DE-0231-BLA	372	8435381452902	PX-0162-CEM	258, 298	8445386074863
30-8550-81-37	460	8445386132471	DE-0232-BLA	372	8435381452919	PX-0171-ANT	98, 184	8445386108845
30-8551-14-F9	460	8445386132679	DE-0233-BLA	374	8435381452759	PX-0172-ANT	98, 253	8445386115448
30-8644-81-92	446	8445386486918	DE-0268-BLA	356	8435381494520	PX-0173-ANT	98, 253	8445386115894
30-8644-81-93	446	8445386486932	DE-0268-NEG	356	8435381494537	PX-0174-ANT	100, 174	8445386110790
30-8645-81-92	448	8445386487007	DE-0271-BLA	382, 402	8435381458669	PX-0176-ANT	100, 252	8445386116006
30-8645-81-93	448	8445386487014	DE-0271-NEG	382, 402	8435381458676	PX-0197-NEG	162	8445386108476
71-1843-81-81	507	8435381401672	DE-0272-BLA	396, 402	8435381458683	PX-0203-NEG	176	8435381084940
71-1843-CF-CF	486, 492, 504, 506, 507	8435381401689	DE-0272-NEG	396, 402	8435381458690	PX-0214-NEG	124	8435381452605
71-1844-81-81	507	8435381401696	DE-0314-ULO	336	8435381457167	PX-0240-OXI	230	8435381454166
71-1844-CF-CF	486, 492, 504, 506, 507	8435381401702	DE-0314-MAD	334	8445386082011	PX-0246-INO	232	8435381454241
71-1964-CF-CF	502	8435381402433	DE-0383-SAT	386	8435381493530	PX-0251-INO	232	8435381456600
71-4393-CF-CF	462	8435381401658	DE-0426-CRO	418	8435381497811	PX-0252-NEG	238	8435381454332
71-4393-N3-N3	462	8435381401665	DE-0428-CRO	422	8435381498108	PX-0254-NEG	180	8435381457051
71-4398-16-F9	454	8435381462475	DE-0429-CRO	422	8435381498115	PX-0263-NEG	102, 304	8445386108537
71-4398-J7-F9	454	8435111082621	DE-0430-CRO	418	8435381498986	PX-0281-NEG	154	8435381456160
71-4398-J7-F9	454	8435111082621	DE-0442-SAT	358	8435381496456	PX-0284-GRI	142	8435381457310
71-4867-11-11	486	8435381425241	DE-0474-BLA	306, 388	8435628665079	PX-0285-GRI	142	8435381457327
71-4867-13-13	486	8435381425258	DE-0474-NEG	306, 388	8435629762466	PX-0303-NEG	136	8445386117225
71-4867-24-24	486	8435381425265	DE-0477-BLA	384	8435628666502	PX-0306-GRI	82, 272	8445386132280
71-4932-00-00	507	8435381425227	DE-0479-BLA	344	8435675318978	PX-0307-GRI	82, 272	8445386132297
71-4933-00-00	507	8435381425234	DE-0479-NEG	344	8435628666607	PX-0308-GRI	82, 272	8445386132303
71-6054-00-00	507	8435381471637	DE-0480-BLA	344	8435675318985	PX-0349-GRI	132	8445386117928
71-8345-05-05	456, 457	8445386076171	DE-0480-NEG	344	8435628666663	PX-0350-BLA	145	8445386118406
71-8409-20-20	496	8445386081595	DE-0481-BLA	344	8435675318992	PX-0350-NEG	148	8445386118413
71-8409-34-34	496	8445386081601	DE-0481-NEG	344	8435628666656	PX-0351-BLA	148	8445386118420
DE-0000-BLA	378	8435575399852	DE-0488-NEG	322	8435628687462	PX-0351-NEG	148	8445386118437
DE-0001-BLA	378	8435575399859	DE-0490-NEG	310	8435628674019	PX-0352-BLA	164	8435381493783
DE-0002-SAT	358	8435575399856	DE-0492-BLA	384	8435675322653	PX-0352-GRI	164	8435381457072
DE-0003-SAT	362	8435575399853	DE-0500-NEG	382	8435675322806	PX-0352-NEG	164	8435381457085
DE-0004-SAT	378	84355753998570	DE-0508-NEG	322	8435675321556	PX-0353-GRI	180	8435381458843
DE-0006-MAD	398, 407	8435629762794	DE-0509-BLA	374	8435381459534	PX-0353-NEG	180	8435381458836
DE-0007-MAD	318, 406	8435629762800	DE-0509-NEG	374	8435675322714	PX-0355-INO	111	8435381459288
DE-0008-MAD	318, 406	8435629762817	DE-0510-BLA	330	8435675322752	PX-0357-NEG	138	8445386117256
DE-0010-MAD	316	8435629762732	DE-0510-NEG	330	8435675322769	PX-0358-NEG	138	8445386117249
DE-0011-NEG	320	8435629762718	DE-0513-BLA	35	8435675324237	PX-0359-BLA	216	8445386116693
DE-0014-BLA	348	8445386076539	PX-0005-ANT	182	8435381434878	PX-0359-NEG	216	8445386116709
			PX-0005-GRI	182	8435111054772	PX-0360-NEG	216	8445386116525



REFERENCE	PAGE	EAN13
PX-0361-NEG	126	8435381458706
PX-0366-NEG	190	8445386116532
PX-0367-ANT	186	8445386116679
PX-0370-ALU	134	8445386117904
PX-0371-ALU	134	8445386117911
PX-0372-NEG	170	8445386116761
PX-0373-ANT	112	8445386117461
PX-0374-NEG	212	8435381494452
PX-0375-ANT	202	8435381493714
PX-0375-BLA	202	8435381493691
PX-0376-ANT	202	8435381493745
PX-0376-BLA	202	8435381493721
PX-0378-GR1	206	8435381493912
PX-0378-NEG	206	8435381493929
PX-0379-GR1	206	8435381493936
PX-0379-NEG	206	8435381493943
PX-0380-GR1	264	8435381493950
PX-0380-NEG	264	8435381493967
PX-0383-ANT	178	8445386116662
PX-0383-ANT	286	8445386116662
PX-0395-GR1	204	8435381493882
PX-0395-NEG	204	8435381493851
PX-0396-GR1	204	8435381493868
PX-0396-NEG	204	8435381493875
PX-0397-GR1	210	8435381493899
PX-0397-NEG	210	8435381493905
PX-0423-GR1	132	8445386397191
PX-0432-ANT	218	8435381495251
PX-0432-BLA	218	8435381495244
PX-0433-ANT	208	8435381495237
PX-0433-BLA	208	8435381495220
PX-0439-NEG	160	8435381497248
PX-0451-NEG	96, 128	8445386682259
PX-0454-ANT	166	8445386486833
PX-0463-ANT	186	8445386638003
PX-0464-GR1	268	8435526865673
PX-0465-INO	144	8435526865697
PX-0468-ANT	214	8435526867257
PX-0468-BLA	214	8435526867264
PX-0478-BLA	310	8435526867271
PX-0486-NEG	222, 288	8435526867356
PX-0487-NEG	251	8435526867349
PX-0487-NEG	288	8435526867349
PX-0493-GR1	156	8435575321625
PX-0493-NEG	156	8435575321632
PX-0499-NEG	192, 282	8445386457987
PX-0500-NEG	242, 282	8445386478470
PX-0501-NEG	242, 282	8445386478456
PX-0502-ANT	248, 280	8445386458168
PX-0503-ANT	248, 280	8445386458175
PX-0504-ANT	224, 280	8445386458182
PX-0507-BLA	160	8435575321588
PX-0507-NEG	160	8435575321595
PX-0510-BLA	262	8445386638300
PX-0512-BLA	262	8445386638317
PX-0513-BLA	262	8445386682495
PX-0514-ANT	37	8435575324183
PX-0515-ANT	36	8435575324190
PX-0516-NEG	37	8435575324206
PX-0517-CEM	234	8435575318991
PX-0518-BLA	262	8445386638324
PX-0520-INO	108	8445386456058
PX-0523-NEG	188, 278	8445386485690
PX-0524-NEG	244	8445386485706
PX-0524-NEG	279	8445386485706
PX-0525-ANT	214	8435575320529
PX-0525-BLA	214	8435575320536
PX-0526-ANT	218	8435575320505
PX-0526-BLA	218	8435575320512
PX-0527-CEM	236, 298	8435575320835
PX-0528-BLA	308	8435575323834
PX-0528-BLA	390	8435575323834
PX-0529-NEG	392	8435575348110
PX-0532-NEG	280, 279	8445386485713
PX-0533-NEG	114, 278	8445386485720
PX-0534-ANT	146, 276	8445386485854
PX-0535-ANT	146, 276	8445386485871
PX-0536-ANT	147, 276	8445386486026
PX-0537-ANT	240, 277	8445386496997
PX-0538-NEG	226, 284	8445386481852
PX-0539-NEG	246, 284	8445386481869
PX-0540-ALU	140	8445386479545
PX-0541-ALU	140	8445386479538
PX-0544-ANT	220, 274	8445386638331

REFERENCE	PAGE	EAN13
PX-0545-NEG	194	8445386458229
PX-0546-NEG	196	8445386458236
PX-0549-ALU	141	8445386627403
PX-0550-NEG	196	8445386479453
PX-0551-NEG	194	8445386479460
PX-0551-NEG	188, 278	8445386485854
PX-0557-ANT	106	8445386485973
PX-0559-BLA	158	8445386637419
PX-0560-BLA	158	8445386637426
PX-0561-ANT	238, 274	8445386638348
PX-0562-ANT	238, 274	8445386638355
PX-0563-NEG	208	8445386638140
PX-0564-NEG	302	8445386638751
PX-0565-NEG	302	8445386638768
PX-0566-NEG	300	8445386638539
PX-1000-INO	110	8435381429973
PX-1100-NEG	112	8435381429980
PX-1400-BLA	122	8435381495268
PX-1400-GR1	122	8435381430023
PX-1400-NEG	122	8435381430016
PX-1801-BLA	264	8435381472856
PX-1801-GR1	264	8435381430047
TC-0000-BLA	44	8435623700130
TC-0001-BLA	44	8435623700147
TC-0002-BLA	44	8435623700154
TC-0003-BLA	44	8435623700161
TC-0004-BLA	44	8435623700178
TC-0005-BLA	44	8435623700185
TC-0006-BLA	44	8435623700192
TC-0007-BLA	44	8435623700208
TC-0046-BLA	84	8445386110752
TC-0046-NEG	84	8445386110769
TC-0047-BLA	84	8445386110776
TC-0047-NEG	84	8445386110783
TC-0070-BLA	76	8445386117263
TC-0070-NEG	76	8445386687644
TC-0071-BLA	76	8445386117317
TC-0071-NEG	76	8445386687651
TC-0072-BLA	54	8445386116815
TC-0073-BLA	54	8445386117010
TC-0074-BLA	54	8445386117027
TC-0075-BLA	90	8445386116853
TC-0076-BLA	86	8435381497262
TC-0078-BLA	342, 404	8445386116587
TC-0078-NEG	342, 404	8445386116594
TC-0079-BLA	328, 404	8445386116600
TC-0079-NEG	328, 404	8445386116617
TC-0080-BLA	352, 405	8445386116624
TC-0080-NEG	352, 405	8445386116631
TC-0081-BLA	40	8445386117683
TC-0082-BLA	40	8445386117690
TC-0083-BLA	40	8445386117706
TC-0084-BLA	40	8445386117638
TC-0085-BLA	40	8445386117645
TC-0105-BLA	78, 332	8445386483535
TC-0106-BLA	78, 332	8445386483532
TC-0111-BLA	76	8445386483593
TC-0112-BLA	60	8445386487187
TC-0112-NEG	60	8445386487175
TC-0113-BLA	60	8445386487182
TC-0113-NEG	60	8445386487199
TC-0118-BLA	56	8445386638782
TC-0119-BLA	56	8445386638799
TC-0120-BLA	56	8445386638805
TC-0121-BLA	56	8445386638812
TC-0134-BLA	62	8435381443757
TC-0135-BLA	62	8435381443740
TC-0148-BLA	42	8435381448950
TC-0149-BLA	42	8435381448967
TC-0150-BLA	42	8435381448974
TC-0151-BLA	42	8435381448981
TC-0154-BLA	43	8435381449018
TC-0155-BLA	43	8435381449025
TC-0156-BLA	43	8435381449032
TC-0157-BLA	43	8435381449049
TC-0160-BLA	69	8435381449070
TC-0161-BLA	69	8435381449087
TC-0162-BLA	69	8435381449094
TC-0163-BLA	69	8435381449110
TC-0166-BLA	70	8435381449131
TC-0167-BLA	70	8435381449148
TC-0168-BLA	70	8435381449155
TC-0169-BLA	70	8435381449162

REFERENCE	PAGE	EAN13
TC-0170-BLA	90	8435381449407
TC-0175-BLA	46	8435381449179
TC-0176-BLA	46	8435381449186
TC-0200-BLA	77	8435381449384
TC-0202-BLA	90	8435381449810
TC-0203-BLA	42	8435381452568
TC-0204-BLA	42	8435381452575
TC-0212-BLA	43	8435381452582
TC-0204-BLA	42	8435381452589
TC-0212-BLA	43	8435381452596
TC-0213-BLA	43	8435381452599
TC-0215-BLA	46	8435381450397
TC-0216-BLA	46	8435381450403
TC-0220-BLA	77	8435381450427
TC-0220-NEG	77	8445386485416
TC-0303-BLA	77	8435381456559
TC-0304-BLA	77	8435381456672
TC-0316-BLA	88	8435381458348
TC-0349-BLA	52	8435381458881
TC-0350-BLA	52	8435381458898
TC-0366-BLA	77	8435381462161
TC-0366-NEG	77	8445386687667
TC-0411-BLA	69	8435381495213
TC-0412-BLA	69	8435381495183
TC-0413-BLA	70	8435381495190
TC-0414-BLA	70	8435381495206
TC-0415-BLA	69	8435381495169
TC-0416-BLA	69	8435381495176
TC-0434-BLA	90	8435381495336
TC-0440-BLA	48	8435381498092
TC-0450-BLA	90	8435381499181
TC-0451-BLA	90	8435381499204
TC-0451-GR1	90	8435381499211
TC-0452-BLA	90	8435381499143
TC-0452-GR1	90	8435381499150
TC-0453-SIN	80	8435381499167
TC-0454-SIN	80	8435381499174
TC-0472-BLA	48	8435526866618
TC-0473-BLA	89	8435526866649
TC-0476-BLA	76	8435526866632
TC-0485-BLA	86	8435526866595
TC-0491-BLA	48	8435526874026
TC-0494-BLA	35	8435575345560
TC-0498-BLA	72	8435575321670
TC-0499-BLA	72	8435575321687
TC-0501-BLA	50	8435575322691
TC-0502-BLA	50	8435575322707
TC-0503-BLA	47	8435575322813
TC-0504-BLA	47	8435575322820
TC-0505-BLA	47	8435575322837
TC-0506-BLA	47	8435575322854
TC-0511-BLA	34, 76	8435575324213
TC-1200-BLA	64	8435381429638
TC-1400-BLA	58	8435381429652
TC-1401-BLA	58	8435381429676
TC-1500-BLA	59	8435381430344
TC-1900-BLA	76	8445386485406
TC-1900-NEG	76	8445386485409
TC-1901-BLA	76	8435381429706
TC-1901-NEG	76	8445386485423
TC-8003-BLA	89	8435381430399
TC-8004-BLA	89	8435381433260
VE-0001-BLA	468	8435575368842
VE-0002-BLA	478	8435575368859
VE-0002-MAD	478	8435575368866
VE-0004-BLA	452	8435575368880
VE-0005-BLA	452	8435575368927
VE-0005-BLA	452	8435575368927
VE-0006-BLA	498	8435575369365
VE-0006-MAR	498	8435575369372
VE-0006-PAT	498	8435575369389
VE-0006-SAT	498	8435575369396
VE-0007-BLA	494	8435575369009
VE-0007-GR1	494	8435575369016
VE-0013-NEG	442	8445386117065
VE-0014-BLA	464	8445386117072
VE-0015-MAR	444	8445386117089
VE-0016-BLA	438	8445386682150
VE-0033-MAD	432	8445386682105
VE-0034-NEG	436	8445386682099
VE-0035-MAD	434	8445386682167

Certificado de garantía
Warranty Certificate
Certificat de garantie

LEDS C4, S.A. garantiza al consumidor y usuario el correcto funcionamiento del producto y posibles reparaciones o suministro de recambios del modelo debidos a defectos de fabricación durante el periodo de **3 o 5 años** desde la fecha de entrega. En www.forlight.com se pueden consultar las condiciones de garantía, de las cuales destacamos las siguientes excepciones:

- En fuentes de luz LED, cuyo funcionamiento supera a las horas de máximo uso por año declaradas en las condiciones de garantía específica del producto.
- Accidentes, o uso negligente, impropio o inadecuado.
- Daños producidos por sobrecargas eléctricas, inundaciones, plagas, terremotos, acciones de terceras partes o cualesquiera otras causas de fuerza mayor ajenas a las condiciones normales de funcionamiento del equipo y al control de LEDS C4, S.A.

This warranty certificate by **LEDS C4, S.A.** is for the consumer and user to guarantee the product works properly, and it covers the model's possible repairs and supply of spare parts due to manufacturing defects for a period of **3 or 5 years** from the delivery date. The warranty terms and conditions can be consulted at the following link www.forlight.com. Please take note of the following exceptions:

- In LED light sources, whose operation exceeds the maximum hours of use per year declared in the specific warranty conditions of the product.
- Accidents or negligent, improper and inappropriate use.
- Damage caused by electrical overloads, floods, infestations, earthquakes, actions of third parties or any other cause of force majeure beyond the normal operating conditions of the equipment and the control of LEDS C4, S.A.

LEDS C4, S.A. garantit au consommateur et utilisateur le fonctionnement correct du produit, ainsi que les éventuelles réparations ou la fourniture de pièces de rechange du modèle dues à des défauts de fabrication pendant une période de **3 ou 5 ans** à compter de la date de livraison. Vous pouvez consulter les conditions de garantie sur www.forlight.com, dont il convient de signaler les exceptions suivantes:

- En sources lumineuses LED, dont le fonctionnement dépasse le nombre maximal d'heures d'utilisation par an déclaré dans les conditions de garantie spécifiques au produit.
- Accidents ou utilisation négligente, impropre ou inadéquate.
- Dommages occasionnés par des surcharges électriques, inondations, fléaux, tremblements de terre, actions de tiers ou toutes autres causes de force majeure indépendantes des conditions normales de fonctionnement du matériel et du contrôle de LEDS C4, S.A.

Información de tarifa
Price list information
Information tarifaire

Todos los precios indicados en el catálogo incluyen la tasa ECORAE.

All prices featured in the catalogue include the WEEE eco-fee.

Tous les prix indiqués dans le catalogue comprennent l'éco-participation DEEE.

**INFORMACIÓN EXTRA
EXTRA INFORMATION
INFORMATIONS SUPPLÉMENTAIRES**

Todos los derechos reservados. Ninguna parte de este libro puede ser reproducida en ningún formato de papel o electrónico, sin el consentimiento previo del editor o de los propietarios de los derechos. Ningún producto del catálogo incluye la bombilla, aunque ésta aparezca en las fotografías.

All rights reserved. No part of this publication may be reproduced or transmitted in any form or by any means, electronic storage and retrieval system, without permission in writing from the copyright owner(s). The products in this catalogue do not include bulbs, although bulbs may appear in the photos.

Tous droits réservés. Aucune partie de ce livre ne pourra être reproduite en format papier ou électronique sans l'autorisation préalable de l'éditeur ou du propriétaire des droits. Les produits de ce catalogue ne comprend pas l'ampoule, mais il semble sur les photos.

Debido a la constante evolución tecnológica del LED, los productos que incluyen esta fuente de luz pueden experimentar variaciones en sus características técnicas con el objetivo de poder ofrecer siempre las máximas prestaciones en nuestros productos.

Due to the constant evolution of LED technology, products containing this light source may vary in their technical characteristics so as to ensure that we can always offer maximum product performance.

En raison de l'évolution constante de la technologie LED, les produits dotés de cette source lumineuse peuvent connaître des variations dans leurs caractéristiques techniques, en vue de toujours en optimiser les prestations.

HEADQUARTERS

Afores s/n
25750 Torà (Lleida) Spain
+ 973 468 100
leds-c4@leds-c4.com

CUSTOMER SERVICE

SPAIN
+ 34 973 468 101
spain@leds-c4.com

GERMANY
+49 209 882 99 021
deutschland@leds-c4.com

EUROPE
+ 34 973 468 102
europe@leds-c4.com

CANADA
Toll-free: + 1-866-5636666
customerserviceUS@leds-c4.com

UNITED KINGDOM
Free-phone: 0808 234 2641
uk@leds-c4.com

ITALY
Toll-free: 800 784 275
italia@leds-c4.com

LATIN AMERICA
+ 34 973 468 115
latinamerica@leds-c4.com

UNITED STATES
Toll-free: + 1-888-3710243
customerserviceUS@leds-c4.com

FRANCE
+ 34 973 468 130
france@leds-c4.com

PORTUGAL
+ 34 973 468 102
portugal@leds-c4.com

ASIA PACIFIC
+ 34 973 468 116
asiapacific@leds-c4.com

AFRICA
+ 34 973 468 116
africa@leds-c4.com

MADRID

Joaquín Turina,2
28224 Pozuelo de Alarcón
Madrid SPAIN

GERMANY

Im Wissenschaftspark Deutschland
GmbH
Munnscheidstraße 14
45886 Gelsenkirchen GERMANY
+49 209 882 99 021
deutschland@leds-c4.com

MIDDLE EAST

Fortune Executive Tower
Cluster T - Office 204
Jumeirah Lake Towers
PO 336910 Dubai - UAE
+ 971 4458 4272
middleeast@leds-c4.com

POLAND

LEDs POLSKA SP Z O.O.
Ul. Palacowa 1
05-816 Michalowice-Wies POLAND
+ 48 71 733 64 01
biuro@leds-polska.pl

ASIA PACIFIC

8 Robinson Road
#03-00 ASO Building
048544 SINGAPORE
+65 8133 5024

SOUTH AFRICA

Office 111, Regus Business Centre
(AMR Building)
3 Concorde Road East
2007 Bedfordview SOUTH AFRICA
+27100075231
SouthAfrica@leds-c4.com

COLOMBIA

Carrera 18 No.86A-14 Oficina 111
110221 Bogotá COLOMBIA
+ 571 6386012

PRESS

comunicacion@leds-c4.com

SUPPLIERS

+ 34 973 468 113

Forlight.com







Afuera s/n 25750 Torà (Lleida) - Spain
www.forlight.com
Tf: + 34 973 468 100